



## NDIS Specialist Disability Accommodation Design Standard





Edition 1.1

The latest edition of this Design Standard can be downloaded from <https://www.ndis.gov.au>

## Acknowledgements

The SDA Design Standard has been developed through extensive consultation and we wish to thank the following key collaborators for their contributions to the content and direction of the document:

### Project management:

Livable Housing Australia

### Technical Standard Writing Team:

- Farah Madon, Vista Access Architects, Lead Author
- Bruce Bromley, Equal Access Group
- Eric Martin, Eric Martin and Associates

### Steering Committee Organisations:

- NDIS Housing Team
- Master Builders Australia
- PowerHousing Australia
- Vista Access Architects
- Equal Access Group
- Eric Martin and Associates
- Summer Housing
- Disability Services Consulting
- Hume Community Housing Association
- Stockland
- North Coast Community Housing

### We would like to thank these organisations for providing supporting feedback, photos and figures:

- NDIS Stakeholder Reference Group
- Figures and Diagrams - Farah Madon (Vista Access Architects)
- Photos by Raja Relf (Photographer Mark Relf)
- Photos by Kennedy Associates Architects (Photographer - Ben Guthrie)
- Photos by Stanton Dahl Architects (Photographer Evan Maclean Photography)
- Photos by Inclusive Living - Granberg of Sweden
- Photos by Inhousing (Photographers, Randy Larcombe and Vanessa Size)

### Graphic Design:

Shel Design

## Foreword



**Hon Stuart Robert MP  
Minister for the National  
Disability Insurance Scheme  
and Minister for  
Government Services**

On behalf of the COAG Disability Reform Council (DRC), it is with great pleasure that I release the SDA Design Standards in accordance with the DRC response to the recommendations of the Specialist Disability Accommodation (SDA) Pricing and Payments Framework Review in 2018.

The release of the SDA Design Standards marks an important milestone in the maturing of the SDA market. The improved clarity of design requirements, together with the opportunity for pre-certification at the planning stage will add to provider confidence and surety of compliance, ultimately strengthening the market. This approach will ensure participants continue to have access to high quality, well-maintained SDA.

The purpose of the National Disability Insurance Scheme (NDIS) is to improve the economic and social outcomes for Australians with a significant and permanent disability by providing them with funding for reasonable and necessary supports.

For eligible participants, SDA is a life-changing support. SDA empowers participants through greater control, independence, privacy and opportunities to maintain and grow personal relationships. It is estimated that around 28,000 or 6.1 per cent of NDIS participants will be eligible for SDA once it is fully rolled out.

The SDA funding approach promotes and encourages a broad range of high-quality housing models and configurations. This flexibility responds to the diversity of participant needs and preferences.

My DRC colleagues and I look forward to continuing to work with participants, providers, investors and key stakeholders to build the SDA market and improve choices and outcomes for eligible participants and their families.

# Contents

Foreword **3**

## Introduction

National Disability Insurance Scheme (NDIS) **7**

Specialist Disability Accommodation (SDA) **7**

About this SDA Design Standard document **7**

When can the dwelling be certified? **8**

What are the minimum features required? **8**

Can a design be certified under multiple design categories? **8**

What is the relationship between the NDIS SDA Design Standard and the National Construction Code (NCC)? **8**

Can the Design Requirements be varied to suit a particular participant? **9**

How to read this SDA Design Standard document **9**

## SDA Design Standard

1. General requirements **11**

2. Pedestrian entry from the site boundary **12**

3. Car parking **18**

4. Entrance, doorways and door hardware **22**

5. Corridors **30**

6. Windows **31**

7. Sanitary facilities **33**

8. Kitchen **47**

9. Laundry **54**

10. Bedroom **57**

11. Living area **61**

12. Switches and powerpoints **62**

13. Flooring and slip resistance **63**

14. Internal stairways **64**

15. Use of lifts **65**

16. Common use external areas, private open space and landscaping **66**

17. Storage **67**

18. Breakout room **68**

19. Luminance contrast requirements **69**

20. Ceiling hoists **70**

21. Heating and cooling **71**

22. Emergency power solutions **71**

23. Assistive technology **72**

24. Fire safe design **73**

25. Robust design **74**

Appendix A:

General best practice recommendations **75**

Legislation Commonwealth or State/territory Acts and referenced Australian Standards **80**

Definitions and Glossary **80**





# Introduction

## National Disability Insurance Scheme (NDIS)

The NDIS funds a range of supports and services to people who have permanent and significant disability.

Funding is provided directly to individuals on a reasonable and necessary basis. In order to be considered reasonable and necessary, a support or service:

- Must be related to a participant's disability
- Must not include day-to-day living costs not related to the disability support needs, such as groceries
- Shall represent value for money
- Must be likely to be effective and work for the participant, and
- Shall take into account support given to the participant by formal support services and a participant's family, carers, informal network and the community.

## Specialist Disability Accommodation (SDA)

SDA is one of the supports that may be funded under the NDIS for some participants who have an extreme functional impairment or very high support needs.

SDA refers to accommodation for people who require specialist housing solutions, including to assist with the delivery of supports that cater to their extreme functional impairment or very high support needs. SDA does not refer to the support services, but the homes in which these are delivered. SDA may, for example, have specialist designs for people with very high needs or a location or features that make it feasible to provide complex or costly supports for independent living.

At the centre of the NDIS is the need to maximise the choice and control of the participant, and to promote opportunities for social and economic participation. Accordingly SDA should enhance self-determination and create the conditions required for participants to lead vibrant, safe and independent lives.

The Design Standards herein have been crafted with the intention of improving the lives of participants by assisting them to live in their own home that meets their individual needs and is situated in communities that facilitate social connections and a sense of belonging. The Design Standards focus is on providing a home environment that maximises the capacity of the individual to live as independently as possible incorporating personal support features within contemporary housing practice. Design to reflect an individual's personality and interests is further encouraged. The diversity of accommodation provided should reflect the diversity of choice available to all members of the community.

SDA should be located on suitable parcels of land that support accessible dwelling and outdoor areas. The site should be in close proximity to public transport and amenity. The NDIS enables participants to choose from a variety of offerings as the SDA market matures, however location and access to amenity will be valued above all as it is in all real estate sectors.

## About this SDA Design Standard document

This document sets out the detailed Design requirements that shall be incorporated into **new built** Specialist Disability Accommodation under the National Disability Insurance Scheme. This SDA Design Standard document is based on the four categories of SDA design which are set out in the SDA Rules, namely:

- Improved Liveability
- Robust
- Fully Accessible
- High Physical Support

From 1st July, 2021, all dwelling enrolment applications for Specialist Disability Accommodation (SDA) will be required to include a certificate from an Accredited SDA Assessor nominating the Design Category the dwelling to be enrolled satisfies based on the Design Standards established in this document.

## When can the dwelling be certified?

A dwelling can be certified to a particular Design Category at two stages:

### 1. **Provisional – Design Certification of SDA dwelling**

The dwelling design can be certified as compliant with the design requirements of a particular design category when the design has been submitted for building approval to a regulatory authority such as a council or a certifier.

The certification is called 'Provisional' as the dwelling has not been built at this stage. Only a built dwelling can get a **Final certification** suitable for NDIS enrolment.

### 2. **Final-as-built Certification of SDA dwelling (Mandatory for SDA enrolment)**

The dwelling shall be certified as a particular Design Category when the dwelling is built with the relevant features as listed in the Design requirements section of this SDA Design Standard document.

The advantage of the 2-step certification is to give assurance to Builders and Developers that if the dwelling is constructed based on the certified design then the dwelling will be approved for use as a compliant SDA dwelling by the NDIS.

**Note that density requirements and building type are to be as required by the NDIS and do not form a part of this SDA Design Standard document.**

Dwellings can be certified as compliant by an Accredited SDA Assessor, when compliance with all the provisions of the Clauses applicable to that particular design category as stated in this SDA Design Standard document are met.

## What are the minimum features required?

This SDA Design Standard document sets out the minimum design requirements for each Design Category.

Dwellings of all Design Categories must, as a minimum, contain no less than one of each of the following elements:

- A Kitchen,
- A Bathroom,
- A Living/Dining area,
- An Entrance/Exit; and
- At least one Bedroom per participant.

Note: A bedsit or studio style design (example a motel room, all in one) is not permitted.

Note: In some cases provision of a shared laundry with multiple residents is considered to be reasonable.

## Can a design be certified under multiple design categories?

A single dwelling may be certified under multiple design categories however all shared areas must comply with the minimum requirements of all enrolled Design Categories

## What is the relationship between the NDIS SDA Design Standard and the National Construction Code (NCC)?

The National Construction Code (NCC) sets out the minimum construction requirements for all new building work in Australia. The dwelling is required to comply with all applicable requirements of the NCC, including but not limited to waterproofing and termite protection measures. Apart from the spatial requirements as noted in this NDIS SDA Design Standard, where there is a conflict between the NCC and the NDIS SDA Design Standard, the NCC takes precedence.



## Can the Design Requirements be varied to suit a particular participant?

At the design stage the individual participant's requirements may be unknown and therefore each design requirement will need to be satisfied to the category(s) selected.

The SDA Design Standard requirements have been determined as a minimum to be reasonable and necessary for the SDA participants based on their needs.

## How to read this SDA Design Standard document

Words with specific meanings are defined in definitions / glossary section of this SDA Design Standard document.

The table has:

- A Clause number for reference
- Design Requirements - which is a minimum requirement for Deemed-to-Satisfy with the SDA Design Standard document.
- The Rationale column which details the reasoning behind the requirement and also provides some further clarifications.
- The Design Category that the Design requirement relates to.

The following key images are used.

### LEGEND



#### Improved Liveability

Housing that has been designed to improve 'Liveability' by incorporating a reasonable level of physical access and enhanced provision for people with sensory, intellectual or cognitive impairment.



#### Fully Accessible

Housing that has been designed to incorporate a high level of physical access provision for people with significant physical impairment.



#### Robust

Housing that has been designed to incorporate a reasonable level of physical access provision and be very resilient, reducing the likelihood of reactive maintenance and reducing the risk to the participant and the community.



#### High Physical Support

Housing that has been designed to incorporate a high level of physical access provision for people with significant physical impairment and requiring very high levels of support.

The SDA Design Standard document also provides some figures to assist with the explanation of the Clauses.

Unless a range of dimensions is specified, all dimensions noted in the figures are the minimum required and in millimetres (mm).


Note that photos provided in this document shall not be relied on for design or assessment.




Details provided in Appendix A are for information / best practice only.

# Specialist Disability Accommodation Design Standard







# 1. General requirements



Clause	Design Requirement	Rationale	Applicable to
1.1	<p>Dwelling shall have:</p> <ul style="list-style-type: none"> <li>• One bedroom exclusively for use of a participant and</li> <li>• The following noted features on an entry level or level serviced by a lift:               <ul style="list-style-type: none"> <li>- One WC pan,</li> <li>- One shower,</li> <li>- One hand wash basin,</li> <li>- One living area,</li> <li>- One kitchen, and</li> <li>- One laundry.</li> </ul> </li> </ul>	<p>Note: Sizes of all rooms and areas are determined by the design category.</p> <p>It is reasonable for a shared laundry to be provided as long as an accessible path of travel is provided to the same from the dwelling.</p> <p>In Improved Liveability design category, it is reasonable for bedrooms to be provided on a floor level that has access only via steps.</p>	

1.2	<p>Dwelling shall have the following noted features on an entry level or a level serviced by a lift:</p> <ul style="list-style-type: none"> <li>• One bedroom exclusively for use of a participant,</li> <li>• One WC pan,</li> <li>• One shower,</li> <li>• One hand wash basin,</li> <li>• One living area,</li> <li>• One kitchen, and</li> <li>• One laundry.</li> </ul>	<p>Note: Sizes of all rooms and areas are determined by the design category.</p> <p>It is reasonable for a shared laundry to be provided as long as an accessible path of travel is provided to the same from the dwelling.</p>	  
-----	--	---	---



LEGEND	 Improved Liveability	 Robust	 Fully Accessible	 High Physical Support
--------	--	--	--	---

## 2. Pedestrian entry from the site boundary

Clause	Design Requirement	Rationale	Applicable to
2.1	<p>A safe, continuous step-free accessway shall be provided from the front boundary of the site to an entry doorway of the dwelling.</p> <p>Note: The accessway may include a walk way, step ramp or ramp and shall include any additional enhanced requirements of the particular design category as noted in this SDA Design Standard document.</p>	<p>Participants residing in Fully Accessible and High Physical Support design category dwellings may require the use of a wheelchair for mobility and therefore a step-free, wheelchair accessible connection from the site boundary to an entry doorway of the dwelling is considered to be an essential design feature to encourage independent access.</p> <p>A concession from this requirement may be granted on larger parcels of land excluding medium and high density locations.</p>	
2.2	<p>A safe, continuous step-free accessway shall be provided from the front boundary of the site to an entry doorway of the dwelling.</p> <p>Note: The accessway may include a walkway, step ramp or ramp and shall include any additional enhanced requirements of the particular design category as noted in this SDA Design Standard document.</p> <p>OR</p> <p>If a safe, continuous step-free accessway from the front boundary of the site to an entry doorway of the dwelling cannot be provided, then step free accessway shall be provided from a car parking space as detailed under Clause 3 to an entry doorway of the dwelling.</p>	<p>Participants residing in Improved Liveability and Robust design category dwellings may not require the use of a wheelchair for mobility and therefore would not necessarily be affected adversely by this concession. Alternative step-free accessway by means of a car parking space is therefore considered to be reasonable in lieu of step-free accessway from the front boundary of the site.</p>	

### LEGEND



Improved Liveability










Robust



Fully Accessible



High Physical Support

Clause	Design Requirement	Rationale	Applicable to
2.3	<p>An accessway shall have:</p> <ul style="list-style-type: none"> <li>• No steps,</li> <li>• A level transition of surface materials,</li> <li>• A maximum vertical tolerance of 3mm or 5mm between abutting surfaces is permitted, as long as the lip is rounded or bevelled,</li> <li>• An even and firm surface, and</li> <li>• A crossfall of not more than 1:40.</li> </ul>	Required to enable safe access to users.	   
2.4	<p>1:20 grade is permitted as a part of the accessway and where provided shall incorporate the following:</p> <ul style="list-style-type: none"> <li>• 1200mm length mid-landings, in the direction of travel (of the same width as walkway width) provided every 15M. Additional landing size shall be provided as per AS1428.1 where a change in direction is required.</li> <li>• The floor surface abutting the sides of a 1:20 grade walkway is provided with a firm and level surface which can be a different material at the same level and grade of the walkway, and extend horizontally for an additional minimum of 600mm, from an accessway unless one of the following is provided: kerb, kerb-rail and handrail or wall (min 450mm height) to comply with the requirements of AS1428.1.</li> <li>• Slip resistance shall be a minimum of P4 or R11.</li> </ul>	<ul style="list-style-type: none"> <li>• Compliance with AS1428.1 is considered to be relevant as it sets out the requirements generally for the 80th percentile wheelchair size except at accessways at the location of a turn greater than 60°, sanitary facilities and at doorways, including door width and circulation space, where it provides suitable sizes for the 90th percentile wheelchair size.</li> <li>• Widths of the walkway and circulation space requirements are based on the requirements of a particular design category.</li> </ul>	   

**LEGEND**



Improved Liveability




Robust







Fully Accessible




High Physical Support

Clause	Design Requirement	Rationale	Applicable to
2.5	<p>1:10 grade step ramp is permitted as a part of the accessway and where provided shall incorporate the following:</p> <ul style="list-style-type: none"> <li>The maximum level change or transition which can be dealt with by a step ramp is 190mm and maximum length of ramp is 1900mm</li> <li>All features of 1:10 step ramp including landing sizes, handrails / kerbrails (if required) shall comply with the requirements of AS1428.1.</li> <li>Slip resistance shall be a minimum of P5 or R12</li> </ul>	<ul style="list-style-type: none"> <li>Compliance with AS1428.1 is considered to be relevant as it sets out the requirements generally for the 80th percentile wheelchair size except at accessways at the location of a turn greater than 60°, sanitary facilities and at doorways, including door width and circulation space, where it provides suitable sizes for the 90th percentile wheelchair size.</li> <li>Widths of the ramp and circulation space requirements are based on the requirements of a particular design category.</li> <li>Any required landing space shall be fully within the property boundary.</li> </ul>	



LEGEND	 Improved Liveability	 Robust	 Fully Accessible	 High Physical Support
--------	--	--	--	---

Clause	Design Requirement	Rationale	Applicable to
2.6	<p>Where the level difference is over 190mm, a maximum grade of 1:14 ramp is permitted as a part of the accessway and where provided shall incorporate the following:</p> <ul style="list-style-type: none"> <li>• 1200mm length landings, in the direction of travel (of the same width as ramp width) provided at base and top of the ramp and at maximum intervals of 9M. Additional landing spaces shall be provided at turns and changes in direction as required under AS1428.1.</li> <li>• All features of 1:14 ramps including handrail profile, handrail extensions and kerb rails shall comply with the requirements of AS1428.1</li> <li>• Slip resistance shall be a minimum of P4 or R11.</li> </ul>	<ul style="list-style-type: none"> <li>• Compliance with AS1428.1 is considered to be relevant as it sets out the requirements generally for the 80th percentile wheelchair size except at accessways at the location of a turn greater than 60°, sanitary facilities and at doorways, including door width and circulation space, where it provides suitable sizes for the 90th percentile wheelchair size.</li> <li>• Widths of the ramp and circulation space requirements are based on the requirements of a particular design category.</li> <li>• Any required landing space shall be fully within the property boundary.</li> <li>• In case of a standalone house, TGSIs should only be provided if specifically required by the participants.</li> <li>• Where the NCC mandates use of TGSIs, consideration to be given to their removal by means of a BCA Performance Solution of handrails having a raised tactile warning indicators, in the form of a domed button 4 mm to 5 mm in height and 10 mm to 12 mm in diameter on the top of the handrail, 150 ±10 mm from the end of the handrail.</li> </ul>	

**LEGEND**



Improved Liveability










Robust



Fully Accessible



High Physical Support

Clause	Design Requirement	Rationale	Applicable to
2.7	The minimum clear width of an accessway shall be 1000mm measured from a narrowest part of the accessway (for example skirting to skirting). This includes all ramps within the accessways.	<ul style="list-style-type: none"> <li>Required for easy and safe access along a walkway.</li> <li>Where ramps are provided in the accessway, the clear width dimension is to be measured between handrails.</li> </ul>	 
2.8	The minimum clear width of an accessway shall be 1200mm measured from a narrowest part of the accessway (for example skirting to skirting). This includes all ramps within the accessways.	<ul style="list-style-type: none"> <li>Enhanced requirement for users that require additional circulation space.</li> <li>Where ramps are provided in the accessway, the clear width dimension is to be measured between handrails.</li> </ul>	 
2.9	Where provided, the minimum clear width of a curved accessway shall be a minimum of 1500mm with a minimum radius of the curvature as specified under AS1428.1. The crossfall shall be towards the centre of curvature.	A person using a wheelchair may not be able to navigate a curved pathway unless the widths and radius of the curvature are as noted in AS1428.1	 
2.10	Where a ramp or walkway is part of the accessway, level landings no less than 1200mm x 1200mm, exclusive of the swing of the door or gate that opens onto them, shall be provided.	Required for safe resting places and to move to other spaces.	 
2.11	Where a ramp or walkway is part of the accessway, level landings no less than 1200mm x 1200mm, exclusive of the swing of the door or gate that opens onto them, shall be provided. The landing size shall increase based on the required gate / door circulation spaces or change of direction requirements as per AS1428.1.	<p>Door circulation requirements in accordance with AS1428.1 are essential for a person using a wheelchair to be able to operate the door or gate independent of a carer.</p> <p>Door automation at the very onset is considered to be a suitable solution in lieu of the provision of latch side door circulation spaces.</p>	 

**LEGEND**



Improved Liveability



Robust







Fully Accessible

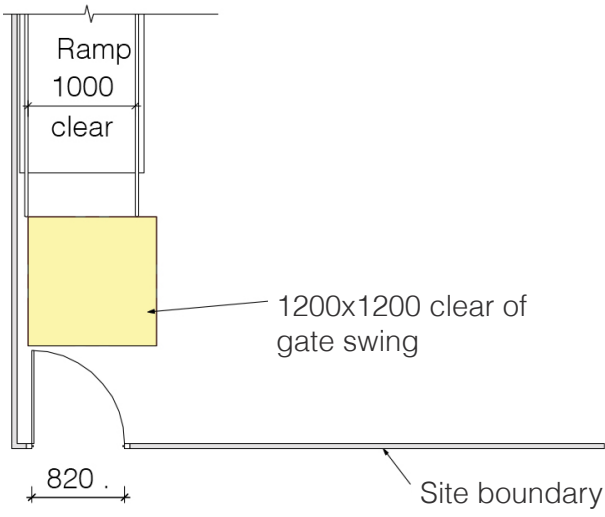


High Physical Support



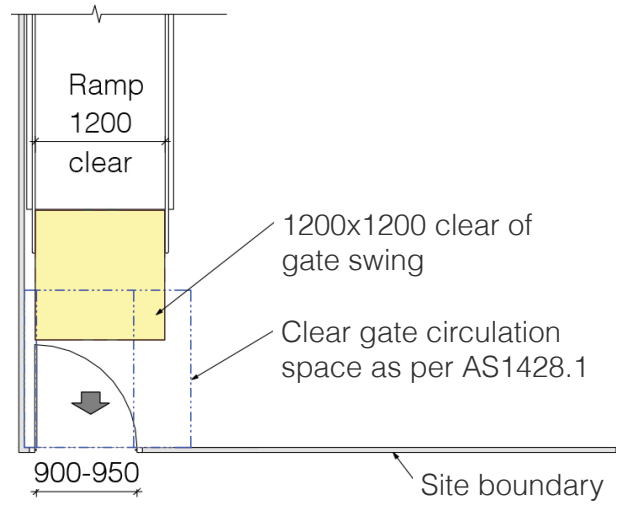
Clause	Design Requirement	Rationale	Applicable to
--------	--------------------	-----------	---------------

2.12	Minimum vertical clearance along all paths of travel to be 2000mm.	Required for safe access on paths of travel.	   
------	--	--	---



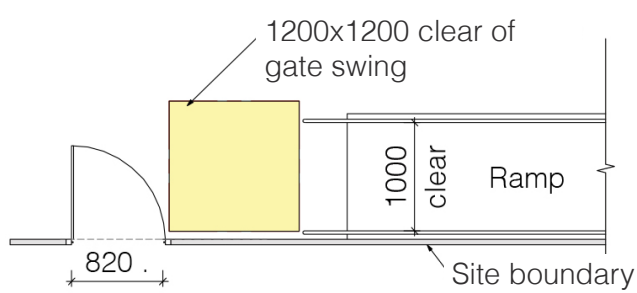
820 min clear opening gate

**Figure 1 (a) Improved Liveability and Robust design categories**



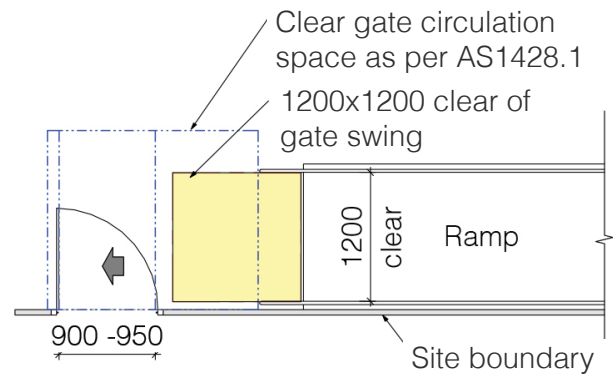
900 min or 950 min clear opening gate based on design category

**Figure 1 (c) Fully Accessible and High Physical Support design categories**



820 min clear opening gate

**Figure 1 (b) Improved Liveability and Robust design categories**



900 min or 950 min clear opening gate based on design category








**Figure 1 (d) Fully Accessible and High Physical Support design categories**

**Figure 1 - Demonstrating required circulation spaces around gates and ramps**

Unless a range of dimensions is specified, all dimensions noted in the figures are the minimum required and in millimetres.

LEGEND	 Improved Liveability	 Robust	 Fully Accessible	 High Physical Support
--------	--	--	--	---

### 3. Car parking

Clause	Design Requirement	Rationale	Applicable to
3.1	<p>A safe, continuous step-free accessway shall be provided from both;</p> <ul style="list-style-type: none"> <li>The front boundary of the site and</li> <li>From any car parking space associated with the dwelling (excluding staff only parking),</li> </ul> <p>to an entry doorway of the dwelling.</p> <p>Note: Concessions apply for Improved Liveability and Robust design categories, as noted in Clause 3.2.</p>	<p>In a multi-storey residential development, where car parking is located in a basement then the provision of a lift or ramp shall be required to provide access from the car parking space to the dwelling.</p> <p>Where parking is exclusively for support staff then no requirements would apply.</p>	   
3.2	<p>Where access cannot be provided as per Clause 3.1, then a safe, continuous step-free accessway shall be provided from a car parking space (as detailed under Clauses 3.3) to an entry doorway of the dwelling.</p>	<p>Participants residing in Improved Liveability and Robust design category dwellings may not require the use of a wheelchair for mobility and therefore may not necessarily be affected adversely by this concession. Alternative step free accessway by means of a car parking space is therefore considered to be reasonable in lieu of step-free accessway from the front boundary of the site.</p>	 
3.3	<p>If providing a car parking space, for use of the participant, it shall be provided with:</p> <ul style="list-style-type: none"> <li>Minimum dimensions of 3200mm (width) x 5400mm (length),</li> <li>An even, firm and slip-resistant surface of P4 or R11, and</li> <li>A level surface with a maximum 1:40 gradient (in any direction).</li> </ul>	<p>Required to provide minimum extra space, to access a vehicle either as a driver or passenger.</p> <p>Gradients are considered to be essential for safety of movement.</p>	 

**LEGEND**



Improved Liveability





Robust



Fully Accessible



High Physical Support

Clause	Design Requirement	Rationale	Applicable to
3.4	<p>If providing a car parking space, for use of the participant, it shall be provided with:</p> <ul style="list-style-type: none"> <li>• Minimum dimensions of 3800mm (width) x 5400mm (length),</li> <li>• An even, firm and slip-resistant surface of P4 or R11,</li> <li>• A level surface with a maximum 1:40 gradient in any direction, and</li> <li>• Roof over space with clear vertical clearance in accordance with AS2890.6</li> </ul>	<p>Required to provide enhanced space, to access a vehicle either as a driver or passenger</p> <p>Gradients are considered to be essential for safety of movement.</p> <p>Car ports comply with the roof over car space requirement.</p>	
3.5	<p>Based on the building classification, the NCC or the local government authority may require the provision of an accessible parking space in accordance with AS2890.6, in which case the full compliance with AS2890.6 shall be required.</p>	<p>As required under the NCC. Use of access symbol and in some cases bollard may not be required (or appropriate) depending on use and management of the parking space.</p>	

**LEGEND**



Improved Liveability



Robust

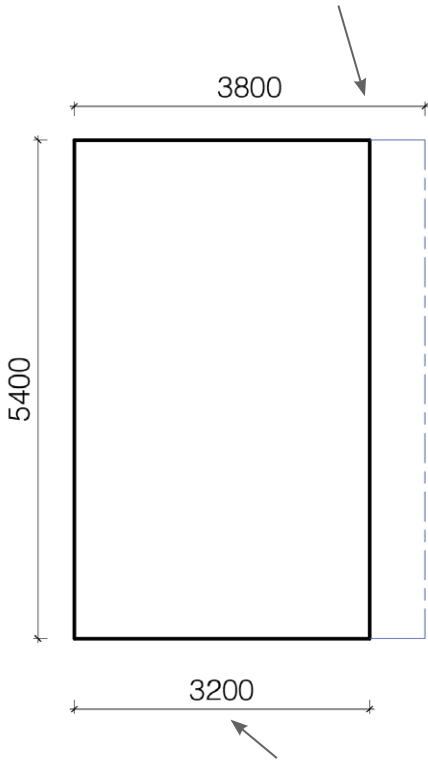


Fully Accessible



High Physical Support

Parking space of 3800 x 5400 where allocated to Fully Accessible and High Physical Support design categories.



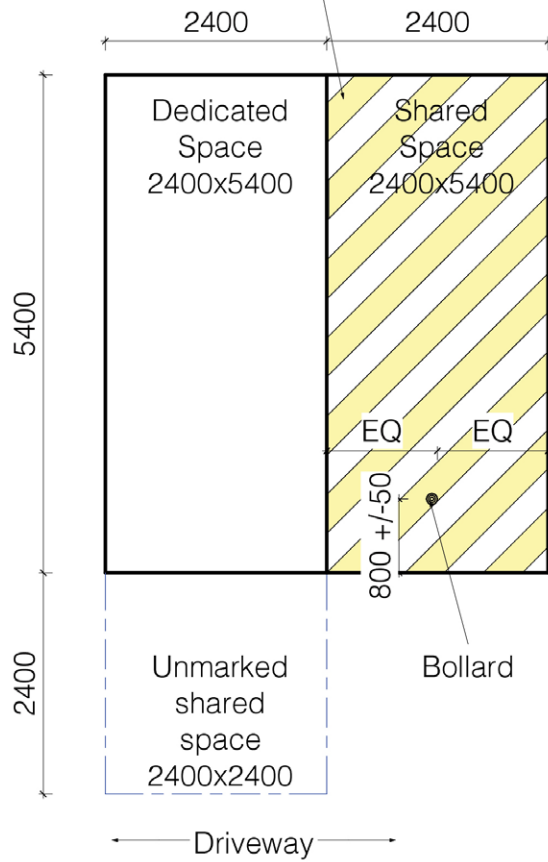
Parking space of 3200 x 5400 where allocated to Improved Liveability and Robust design categories.

**Figure 2 (a) Parking space requirements based on design categories**

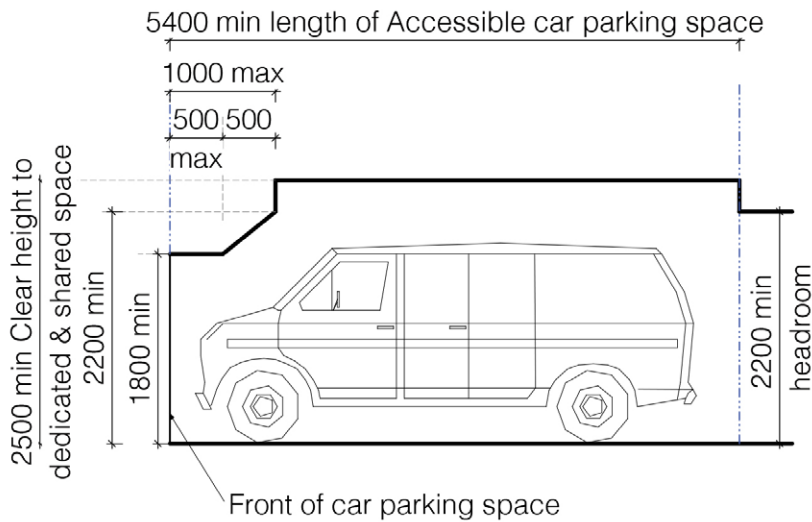
**Figure 2 - Car parking space requirements**

Unless a range of dimensions is specified, all dimensions noted in the figures are the minimum required and in millimetres.

150-200 wide diagonal stripes with spaces 200-300 between stripes at 45+/- 10°



**Figure 2 (b) Accessible Parking space requirements as per AS2890.6 - if mandated under the NCC**

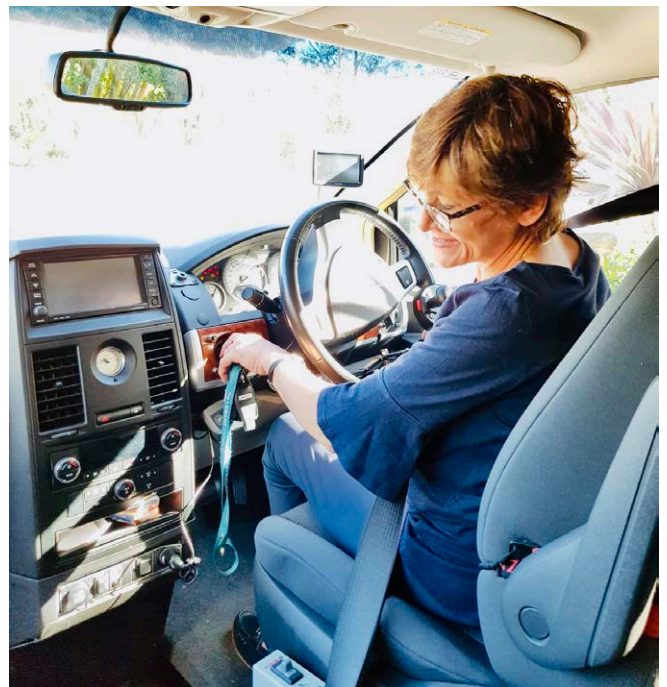


Accessible Parking space head height requirements if mandated under the NCC. Head height requirements also apply to all car parking spaces provided for Fully Accessible and High Physical Support design categories.

**Figure 2 (c) Clear head height requirements for AS2890.6 car parking spaces and shared zones and also applicable to car parking spaces allocated to participants in the Fully Accessible and High Physical Support design categories**

**Figure 2 - Car parking space requirements (continued)**

Unless a range of dimensions is specified, all dimensions noted in the figures are the minimum required and in millimetres.



**LEGEND**



Improved Liveability



Robust







Fully Accessible



High Physical Support

## 4. Entrance, doorways and door hardware

### 4.1 Requirements for dwelling entrance and other external doorways

Clause	Design Requirement	Rationale	Applicable to
4.1.1	<p>A level landing area of at least 1200mm x 1200mm with a maximum 1:40 gradient and crossfall shall be provided at the level (step-free) external entry doorway, on the arrival side of the door (i.e. the external side of the door).</p> <p>Doorway threshold ramp (if required) is permitted to be within the landing area.</p> <p>Entire doorway width shall be in front of the landing area.</p>	<ul style="list-style-type: none"> <li>Required for a safe resting space to access door.</li> <li>Compliance with AS1428.1 is considered to be relevant as it sets out the requirements generally for the 80th percentile wheelchair size except at accessways at the location of a turn greater than 60°, sanitary facilities and at doorways, including door width and circulation space, where it provides suitable sizes for the 90th percentile wheelchair size.</li> <li>Refer to Clause 4.1.5 for doorway threshold ramp requirements.</li> </ul>	 
4.1.2	<p>A level landing area of at least 1500mm x 1500mm with a maximum 1:40 gradient and crossfall shall be provided at the level (step-free) external entry doorway, on the arrival side of the door (i.e. the external side of the door).</p> <p>The level landing area shall be increased to accommodate door circulation spaces as per AS1428.1</p> <p>Doorway threshold ramp (if required) is permitted to be within the landing area.</p>	<ul style="list-style-type: none"> <li>Enhanced requirement for a safe resting space to access door.</li> <li>Compliance with AS1428.1 is considered to be relevant as it sets out the requirements generally for the 80th percentile wheelchair size except at accessways at the location of a turn greater than 60°, sanitary facilities and at doorways, including door width and circulation space, where it provides suitable sizes for the 90th percentile wheelchair size.</li> <li>Refer to Clause 4.1.5 for doorway threshold ramp requirements.</li> </ul>	 

#### LEGEND



Improved Liveability



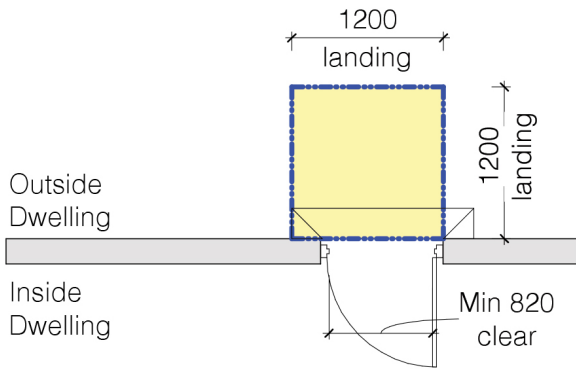
Robust



Fully Accessible

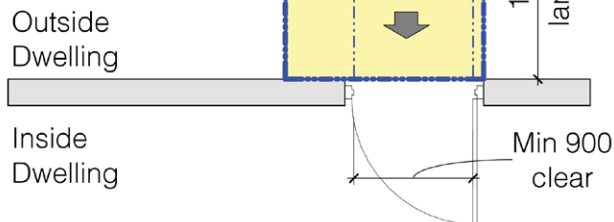


High Physical Support



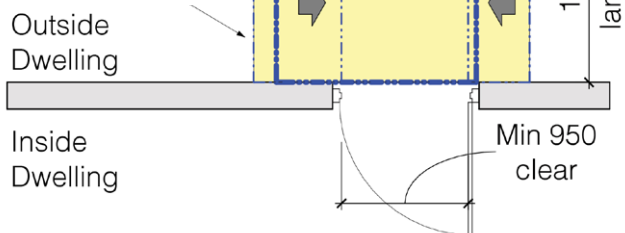
**Figure 3 (a) - Landing space for Improved Liveability and Robust design categories**

Landing space shall increase based on the required door circulation spaces as per AS1428.1



**Figure 3 (b) - Landing space for Fully Accessible design category**

Landing space shall increase based on the required door circulation spaces as per AS1428.1



**Figure 3 (c) - Landing space for High Physical Support design category**

**Figure 3 - Landing Area requirements for the external entry doorway based on the design category**

Unless a range of dimensions is specified, all dimensions noted in the figures are the minimum required and in millimetres.

**Figure 3 (a) - Landing space for Improved Liveability and Robust design categories**

- A level landing area of at least 1200mm x 1200mm with a maximum 1:40 gradient and crossfall shall be provided at the level (step-free) external entry doorway on the arrival side of the door (i.e. the external side of the door).
- Doorway threshold ramp (if required) is permitted to be within the landing area.
- A covered roof area shall be provided over the entire required landing area outside main external entry doorway (shown in yellow).

**Figure 3 (b) - Landing space for Fully Accessible design category**

**AND**

**Figure 3 (c) - Landing space for High Physical Support design category**

- A level landing area of at least 1500mm x 1500mm with a maximum 1:40 gradient and crossfall shall be provided at the level (step-free) external entry doorway on the arrival side of the door (i.e. the external side of the door).
- The level landing area shall increase to accommodate door circulation spaces as per AS1428.1. Figure 3 (b) demonstrates door circulation spaces based on front approach to door and Figure 3(c) demonstrates door circulation spaces based on side approach to door.
- Doorway threshold ramp (if required) is permitted to be within the landing area.
- A covered roof area shall be provided over the entire required landing area outside main external entry doorway (shown in yellow).

**LEGEND**



Improved Liveability









Robust



Fully Accessible



High Physical Support

Clause	Design Requirement	Rationale	Applicable to
4.1.3	All door circulation spaces (excluding internal door circulation spaces for bedrooms) shall be provided in accordance with AS1428.1 to both sides of the door.	<p>Compliance with AS1428.1 is considered to be relevant as it sets out the requirements generally for the 80th percentile wheelchair size except at accessways at the location of a turn greater than 60°, sanitary facilities and at doorways, including door width and circulation space, where it provides suitable sizes for the 90th percentile wheelchair size.</p> <p>Note that doors which swing outside, including any screen doors will also be required to provide door circulation spaces as per AS1428.1</p> <p>A concession to this requirement can be applied to storage and exclusive staff use areas where staff accommodation is provided as a part of the dwelling.</p> <p>Note that door automation cannot replace door circulation space length however door automation is considered an appropriate BCA performance solution in lieu of door latch side clearance.</p> <p>For internal door circulation spaces for bedrooms refer to Figure 16.</p>	 
4.1.4	A covered roof shall be provided over the entire required landing area outside main external entry doorway.	<p>Required for safe and suitable protection while accessing door.</p>	   

**LEGEND**



Improved Liveability



Robust







Fully Accessible





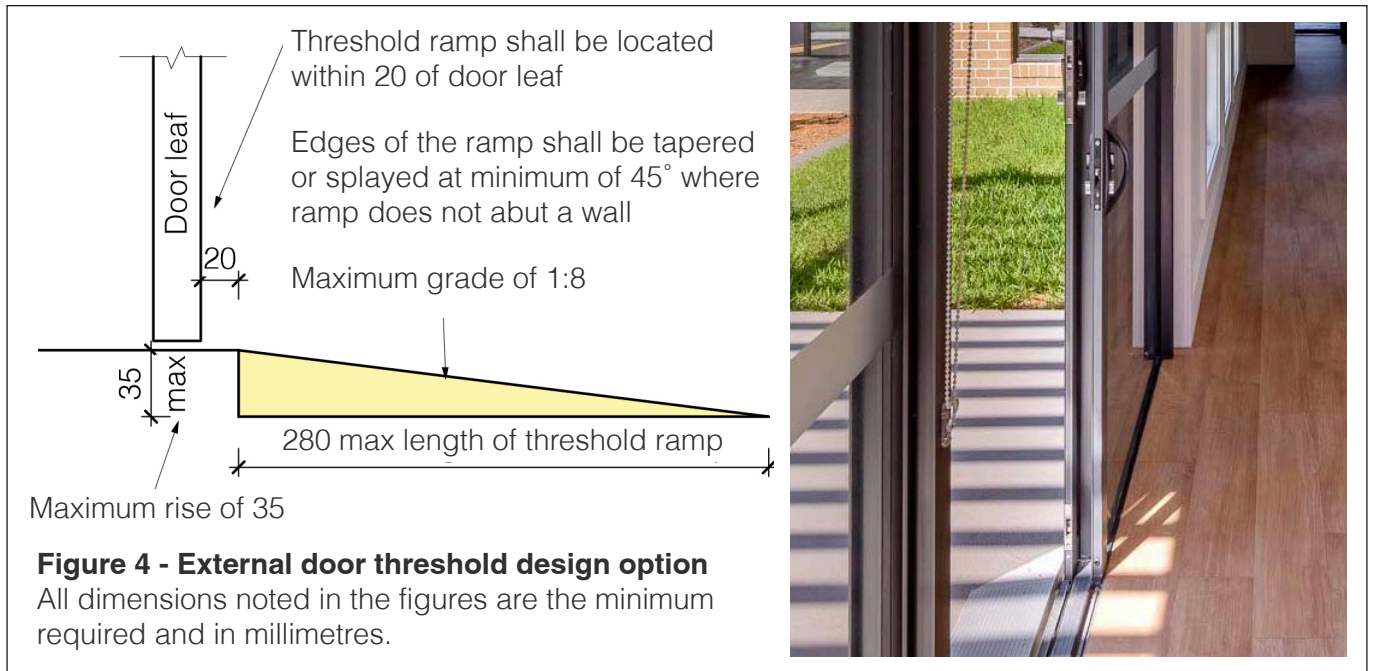
High Physical Support







Clause	Design Requirement	Rationale	Applicable to
--------	--------------------	-----------	---------------

4.1.5	A step-free doorway threshold shall be provided to an external entry doorway. Where the threshold at an external entry doorway exceeds 5mm and is less than 35mm, a doorway threshold ramp in accordance with AS1428.1 shall be provided with a maximum 1:8 grade as shown in Figure 4.	Ideally, flush floor entry is preferred at the external entry doorway threshold in lieu of a threshold ramp. Where provided, a threshold ramp is considered to be suitable to overcome small level differences and afford some weather protection.	   
-------	---	--	---

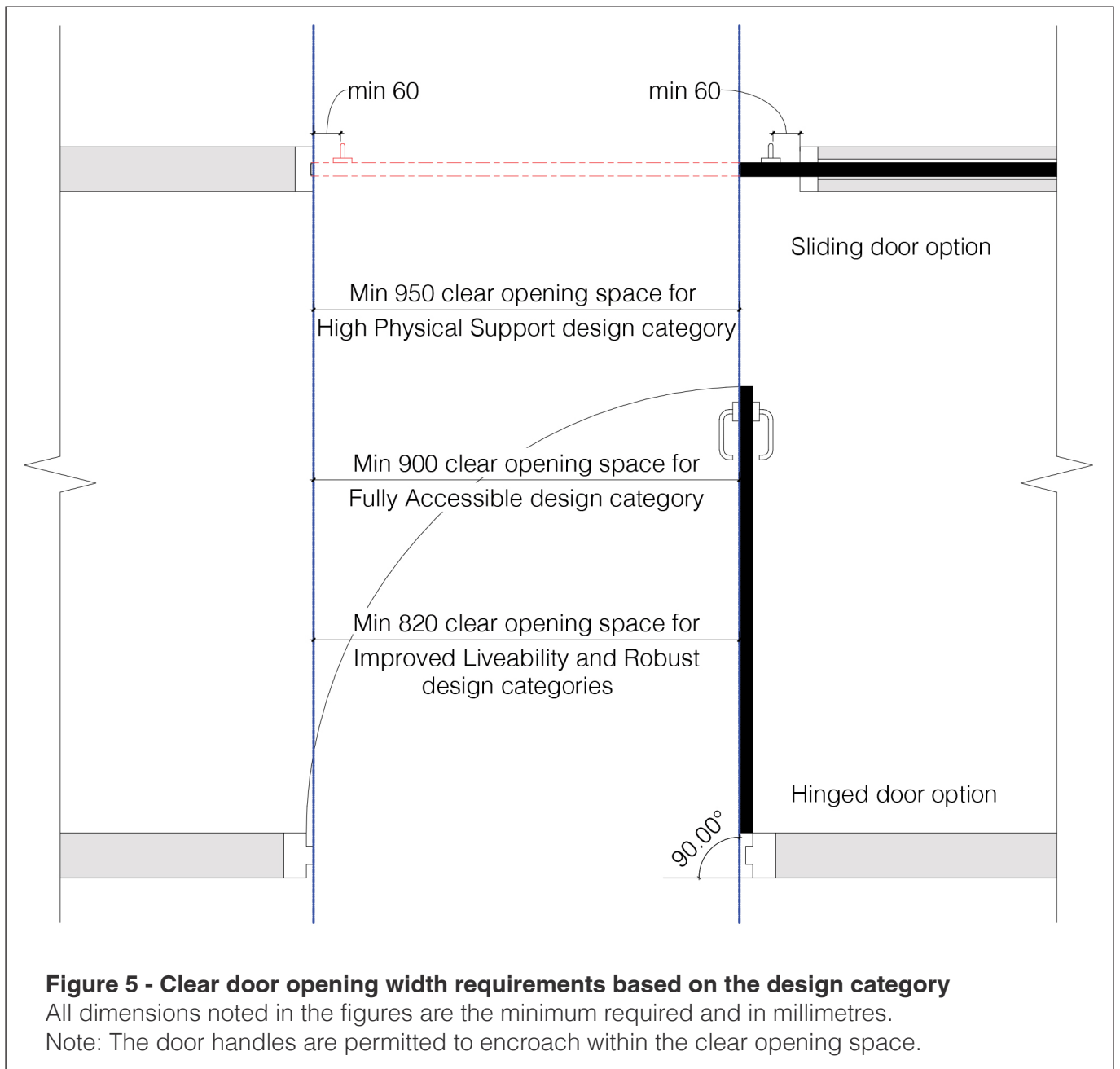
4.1.6	A step-free doorway threshold shall be provided to external doorways leading to common or private open spaces. Where the threshold at the external doorway exceeds 5mm and is less than 35mm, a doorway threshold ramp in accordance with AS1428.1 shall be provided with a maximum 1:8 grade as shown in Figure 4.	Required to enable all users to use both indoor and outdoor spaces.	 
-------	---	---	---



<b>LEGEND</b>	 Improved Liveability	 Robust	 Fully Accessible	 High Physical Support
---------------	--	--	--	---

## 4.2 Requirements for doorways and door handles

Clause	Design Requirement	Rationale	Applicable to
4.2.1	The dwelling shall provide all doors to and within all areas normally used by the participants, including all external doorways with a minimum clear opening width of 820mm, when measured in accordance with Figure 5.	Minimum clear access provided to enable use of facilities. 820mm clear opening to be achieved by one single door panel. Note that the door is required to provide clear opening when open to min 90 degrees angle with the door jamb.	 
4.2.2	The dwelling shall provide all doors to and within all areas normally used by the participants, including all external doorways with a minimum clear opening width of 900mm, when measured in accordance with Figure 5.	Enhanced door clearance as required for some uses. 900mm clear opening to be achieved by one single door panel. Note that the door is required to provide clear opening when open to min 90 degrees angle with door jamb.	
4.2.3	The dwelling shall provide all doors to and within all areas normally used by the participants), including all external doorways with a minimum clear opening width of 950mm, when measured in accordance with Figure 5.	Enables access for users with larger circulation requirements. 950mm clear opening to be achieved by one single door panel. Note that the door is required to provide clear opening when open to min 90 degrees angle with door jamb.	
4.2.4	All internal doorways shall have a level (step-free) transition and threshold (maximum vertical tolerance of 3mm vertical or 5mm between abutting surfaces is allowable provided the lip is rounded or bevelled).	To enable safe and easy access to all areas. It is to be noted that all internal doorways are required to comply with this requirement without the need of doorway threshold ramps which are only permitted for use at external doorways.	   
4.2.5	Doorways shall have door handles installed at between 900mm to 1100mm above the FFL.	To enable door handle to be reachable in both seated and standing position.	   
4.2.6	Door handles selection and location shall comply with AS1428.1 as shown in Figures 6 and 19.	To enable access for all regardless of manual dexterity abilities.	  
<b>LEGEND</b>			
	Improved Liveability		Robust
	Fully Accessible		High Physical Support



**LEGEND**



Improved Liveability








Robust



Fully Accessible



High Physical Support

Clause	Design Requirement	Rationale	Applicable to
4.2.7	<p>Doorway circulation spaces in accordance with AS1428.1 shall be provided to all doorways (excluding exclusive staff use areas, non-accessible toilets and storage rooms).</p> <p>Door automation can be provided in lieu door circulation spaces that are required as per AS1428.1 to the latch side of the door.</p> <p>Note that if door circulation is not provided as per AS1428.1 then door automation must be provided at the onset and not simply provision for door automation at a future time.</p>	<p>To enable safe and easy access to doors.</p> <p>Note that Door automation cannot replace door circulation space length however door automation is considered an appropriate BCA performance solution in lieu of door latch side clearance.</p>	 
4.2.8	<p>Power and control cabling to head of entry doors of participant bedrooms, one external entry doorway and one external doorway to an open area (where provided) shall be provided for future automation.</p> <p>A capped GPO at the door head may be provided to comply with this requirement.</p>		
4.2.9	<p>Timber doors where provided shall be solid core doors.</p>	For safety of users.	
4.2.10	<p>Laminated glass or polycarbonate resin thermoplastic material shall be provided to all glazed areas, glazed doors and side lights.</p>	For safety of users.	

**LEGEND**



Improved Liveability



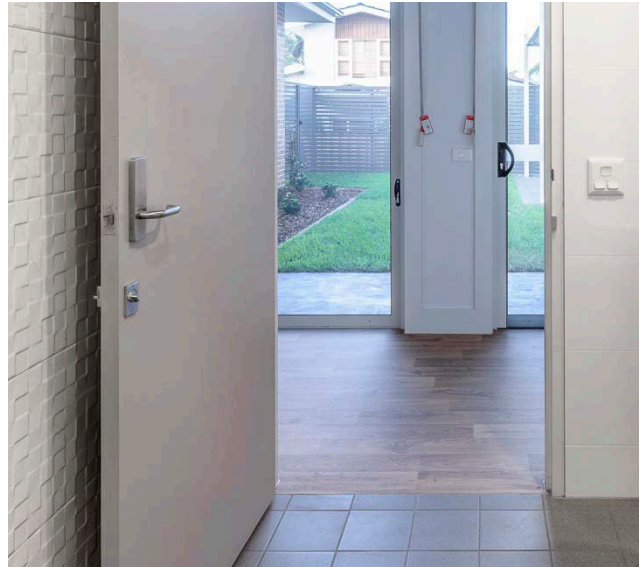
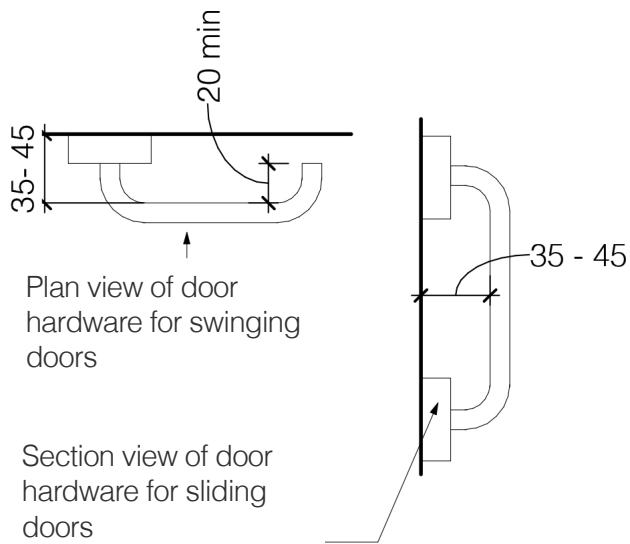
Robust



Fully Accessible



High Physical Support



**Figure 6 - Door hardware requirements for Improved Liveability, Fully Accessible and High Physical Support design categories.**

Unless a range of dimensions are specified, all dimensions noted are minimum required and in millimetres.

**LEGEND**



Improved Liveability



Robust









Fully Accessible



High Physical Support

## 5. Corridors

Clause	Design Requirement	Rationale	Applicable to
5.1	All internal corridors and passageways shall provide a minimum clear width of 1000mm when measured from skirting to skirting.	To enable safe and easy access by users.	 
5.2	All internal corridors and passageways shall provide a minimum clear width of 1200mm when measured from skirting to skirting.	For enhanced safe and easy access by users.	 
5.3	Width of the corridors shall comply with the requirements of door circulation spaces as per AS1428.1 based on direction of approach.  Note: Where AS1428.1 requires corridor width of less than 1200mm, then a minimum clear width of 1200mm shall be provided.	Compliance with AS1428.1 is considered to be relevant as it sets out the requirements generally for the 80th percentile wheelchair size except at accessways at the location of a turn greater than 60°, sanitary facilities and at doorways, including door width and circulation space, where it provides suitable sizes for the 90th percentile wheelchair size.	 



### LEGEND



Improved Liveability



Robust












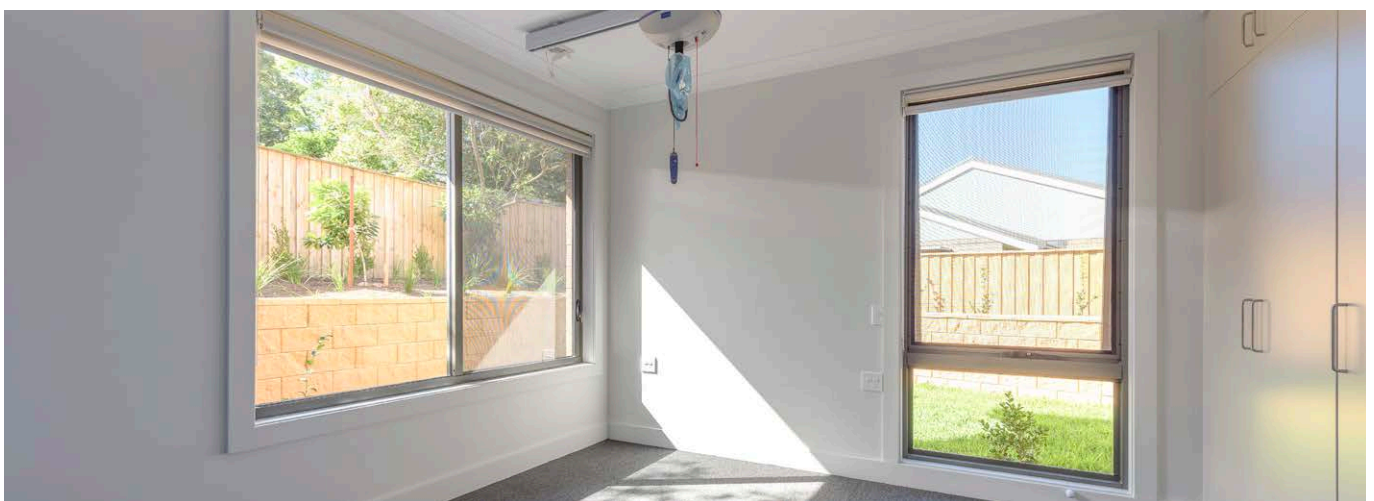
Fully Accessible



High Physical Support

## 6. Windows

Clause	Design Requirement	Rationale	Applicable to
6.1	<p>All window sills in living areas and at least one window sill in each participant's bedroom shall be positioned no higher than 1000mm above the FFL.</p> <p>Note: Concession is reasonable in kitchen, bathroom and utility spaces.</p>	<p>Provided to enable users to see out of window. Each bedroom is required to have at least one glazed area (can be a window or a full height door) to an external wall of that particular room with the noted minimum sill height requirements.</p>	 
6.2	<p>Window controls shall be located within easy reach from either a seated or standing position (between 600mm to 1100mm above FFL).</p> <p>Note: Concession is reasonable in kitchen, bathroom and utility spaces.</p>	<p>Provided to enable controls to be reached by all users.</p>	 
6.3	<p>Power and control cabling to windows of bedrooms and living areas shall be provided for future window blind automation.</p> <p>A capped GPO at the window head may be provided to comply with this requirement.</p>	<p>Provided to enable operation of window covering, where manual operation is difficult through future automation. Automation in the future will allow the opening and closing of window furnishing automatically by remote control or a push button.</p>	
6.4	<p>Provide lockable windows.</p>		   



### LEGEND



Improved Liveability



Robust



Fully Accessible











High Physical Support

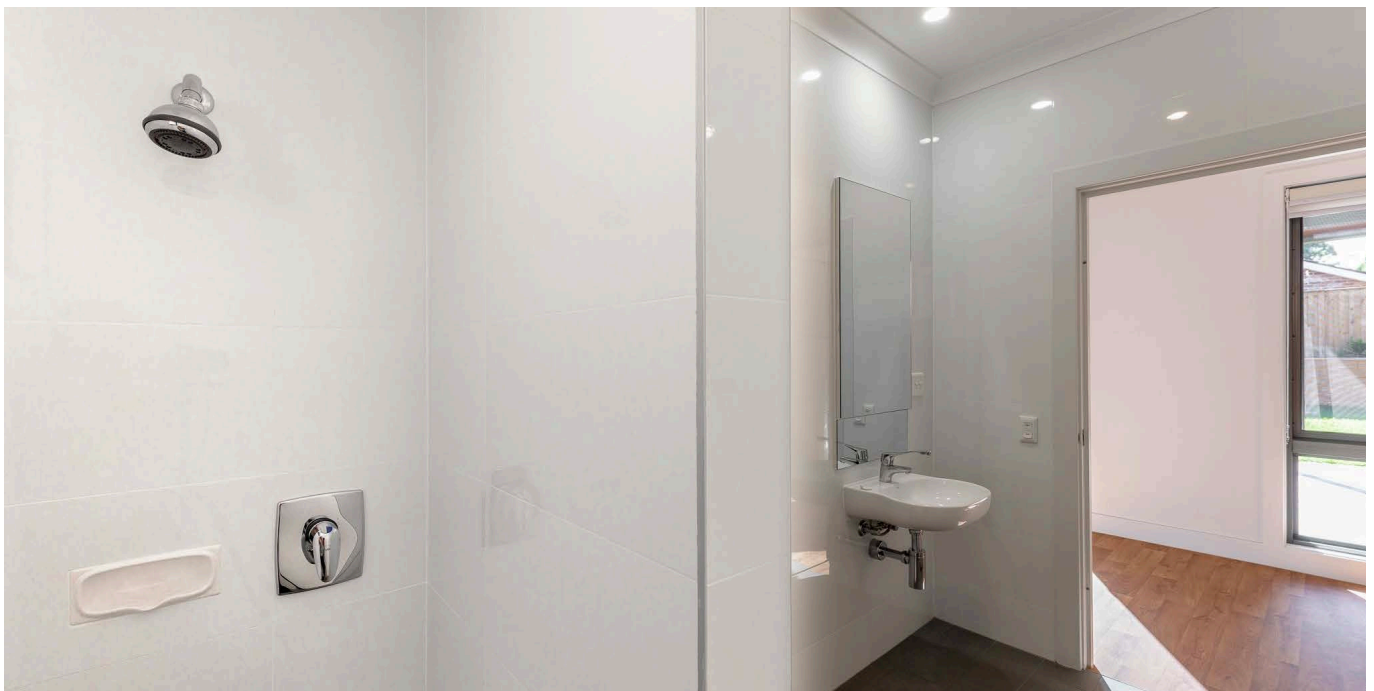




## 7. Sanitary facilities

### 7.1 Internal layout requirements

Clause	Design Requirement	Rationale	Applicable to
7.1.1	The entry level, or a level serviced by a lift, shall be provided with sanitary facilities that include a WC pan, a shower and a hand wash basin.	Bathtubs are not a mandatory requirement but may be provided based on participant's requirements.	   
7.1.2	The required WC pan, shower and hand wash basin referred to in Clause 7.1.1 shall be provided within the same bathroom.	One bathroom is required to fully comply and then if required in shared environments an additional toilet could be provided.	 
7.1.3	At least one WC pan on the entry level, or a level serviced by a lift, shall provide for a minimum clear space of 900mm (width) x1200mm (length immediately forward of the toilet pan) clear of the swing of the door and any other fixtures such as the shower screens or shower screen fixtures or hand wash basin.	For easy access for all users.  Note that the selected WC pan is not required to comply with AS1428.1.  Refer to Figure 7 for details.	 



#### LEGEND



Improved Liveability




Robust



Fully Accessible



High Physical Support

Clause	Design Requirement	Rationale	Applicable to
7.1.4	<p>At least one WC pan on the entry level, or a level serviced by a lift shall be:</p> <ul style="list-style-type: none"> <li>AS1428.1 compliant (as per requirements for unisex accessible toilet and not as per ambulant toilet) and</li> <li>WC pan shall be located with: <ul style="list-style-type: none"> <li>c/l of WC pan at 450mm - 460mm to side wall,</li> <li>800+/-10mm front edge of WC pan from back wall,</li> <li>Minimum 600mm clear of cistern from front edge of WC pan</li> <li>Minimum circulation space of 1900mm x 2300mm as required by AS1428.1</li> <li>Toilet flushing controls shall be proud of the surface</li> <li>Refer to Figure 8(a) for permissible hand wash basin encroachment zone.</li> </ul> </li> </ul>	<p>Design in accordance with AS1428.1 allows for the WC pan to be used by multiple transfer methods based on a 90th percentile wheelchair size. This allows for maximum flexibility for independent use by a person using a wheelchair.</p> <p>Note: The selected WC pan itself must be AS1428.1 compliant however, backrests and grabrails to the WC pan shall not be provided unless specifically required by the participant.</p>	

**LEGEND**



Improved Liveability






Robust



Fully Accessible



High Physical Support

Clause	Design Requirement	Rationale	Applicable to
7.1.5	<p>At least one WC pan on the entry level, or a level serviced by a lift, shall be AS1428.1 compliant (as per requirements for unisex accessible toilet and not as per ambulant toilet) and shall be provided with either:</p> <ul style="list-style-type: none"> <li>c/l of WC pan at 450mm - 460mm to side wall,</li> <li>800+/-10mm front edge of WC pan from back wall,</li> <li>Minimum 600mm clear of cistern from front edge of WC pan</li> <li>Minimum circulation space of 1900mm x 2300mm as required by AS1428.1</li> <li>Toilet flushing controls shall be proud of the surface</li> <li>Refer to Figure 8(a) for permissible basin encroachment zone.</li> </ul> <p>OR</p> <ul style="list-style-type: none"> <li>A minimum circulation space of 900mm to both sides of the WC pan for 2300mm from the back wall of the WC pan shall be provided as required for Accessible Adult change facilities as noted in the NCC.</li> </ul> <p>Refer to Figure 8(b)</p>	<p>Design in accordance with AS1428.1 allows for the WC pan to be used by multiple transfer methods based on a 90th percentile wheelchair size. This allows for maximum flexibility for independent use by a person using a wheelchair.</p> <p>Peninsular type WC pan may be required for High Physical Support needs and the circulation spaces are based on the current version of the NCC.</p> <p>Note: The selected WC pan itself must be AS1428.1 compliant however, backrests and grabrails (or drop down rails) to the WC pan shall not be provided unless specifically required by the participant.</p>	
7.1.6	<p>At least one shower on the entry level, or level serviced by a lift, shall be provided in a corner of the room with a hobless shower recess of minimum 900mm x 900mm clear of any shower screens or shower screen fixtures.</p>	<p>Provide to ensure a minimum level of amenity for participants.</p> <p>Hobless in this document means wheelchair accessible and excludes setdowns or shower screen frames.</p>	 

**LEGEND**



Improved Liveability





Robust



Fully Accessible



High Physical Support

Clause	Design Requirement	Rationale	Applicable to
7.1.7	<p>At least one shower on the entry level, or a level serviced by a lift, shall be provided in a corner of the room with the following provisions:</p> <ul style="list-style-type: none"> <li>The shower size shall be a minimum of 1160mm x 1100mm and provided with one of the two circulation spaces for shower as required by AS1428.1. Refer to Figures 8(c) and 8(d).</li> <li>Shower curtain rail shall be provided around the 1160x1100mm shower space.</li> <li>Only vertical support grabrail shall be provided to the shower, with provision of height adjustable shower head and hose as per AS1428.1</li> <li>Lever style shower tap shall be provided and located in a zone between 900mm to 1100mm above FFL and between 300mm and 800mm from the internal corner.</li> <li>Shower floor gradient shall be as required by AS1428.1.</li> </ul>	<p>Design in accordance with AS1428.1 allows for maximum flexibility for independent use by a person requiring the use of a wheelchair for mobility.</p> <p>Hobless in this document means wheelchair accessible and excludes setdowns or shower screen frames.</p> <p>Any type of floor drain, including strip drains, are permitted to adequately drain the shower floor.</p> <p>Shower seat and horizontal grabrail shall not be provided unless specifically required by the participant.</p>	 

**LEGEND**



Improved Liveability













Robust



Fully Accessible



High Physical Support

Clause	Design Requirement	Rationale	Applicable to
7.1.8	<p>At least one hand wash basin on the entry level, or a level serviced by a lift, shall be AS1428.1 compliant and shall be provided with:</p> <ul style="list-style-type: none"> <li>• A minimum basin depth of 430mm</li> <li>• Minimum circulation space as required by AS1428.1</li> <li>• Encroachment free knee and toe clearance space as per AS1428.1 under the basin for a minimum width of 850mm, centred on the basin.</li> <li>• Sensor type or lever style tapware shall be provided to comply with AS1428.1 and located such that the operable part of lever tap handle and water source are within 300mm from edge of hand wash basin.</li> </ul> <p>Refer to Figures 9(a) and 9(b).</p>	Essential to enable use by a wide range of potential users.	 
7.1.9	If providing a fixed bathtub, it shall be clear of the circulation space requirements of WC pan, shower and hand wash basin.		   
7.1.10	Slip resistance of all floors to sanitary facilities shall be minimum of P3 or R10.		   

**LEGEND**



Improved Liveability



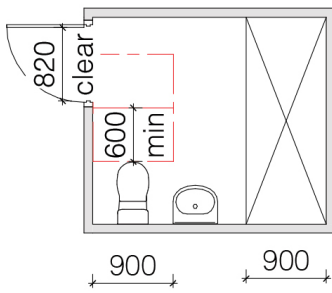
Robust



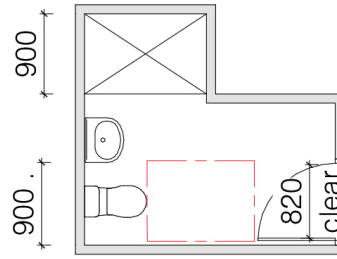
Fully Accessible



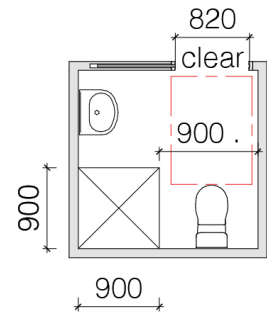
High Physical Support



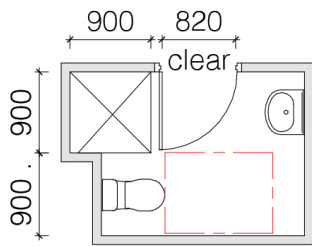
**Figure 7 (a) Bathroom Design Option 1**



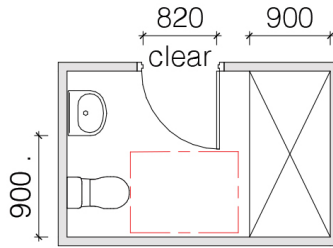
**Figure 7 (b) Bathroom Design Option 2**



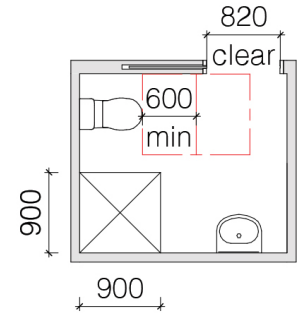
**Figure 7 (c) Bathroom Design Option 3**



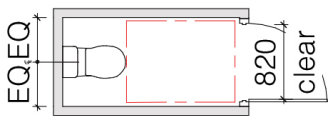
**Figure 7 (d) Bathroom Design Option 4**



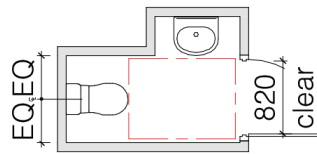
**Figure 7 (e) Bathroom Design Option 5**



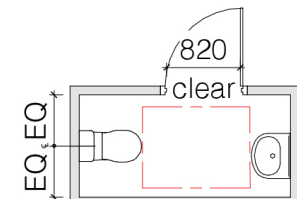
**Figure 7 (f) Bathroom Design Option 6**



**Figure 7 (g) Toilet Design Option 1**



**Figure 7 (h) Toilet Design Option 2**




**Figure 7 (i) Toilet Design Option 3**

**Figure 7 - Sample toilet and shower designs for Improved Liveability and Robust design categories**

Notes:

- Unless a range of dimensions is specified, all dimensions noted in the figures are the minimum required and in millimetres.
- WC pan is not required to comply with AS1428.1. In designs where the nearside wall adjacent to the WC pan includes a doorway (and a wall is not available on the other side of the WC pan), for example Figure 7(a), then a 600mm minimum length reinforced wall shall be clear of the door frame.
- A shower is permitted to be in another room as long as it is on the entry level. Shower shall have an internal size of 900mm x 900mm, clear of any shower fittings or frames.
- Internal side of full sanitary facility shall have wall reinforcement which consists of minimum 12mm thick sheeting, from FFL and extending to a height of minimum 2100mm from FFL.

 Indicates a clear space of 900mm x 1200mm

**LEGEND**



Improved Liveability



Robust

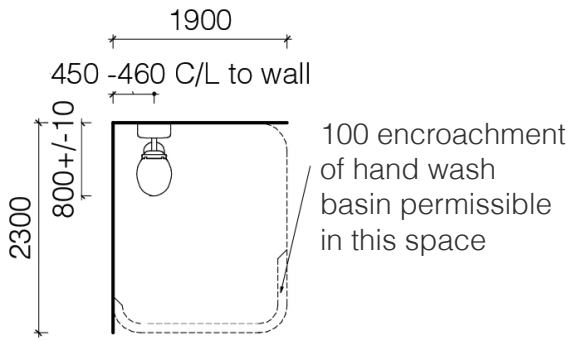


Fully Accessible

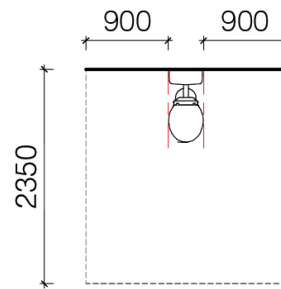


High Physical Support

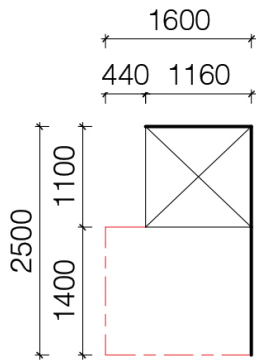




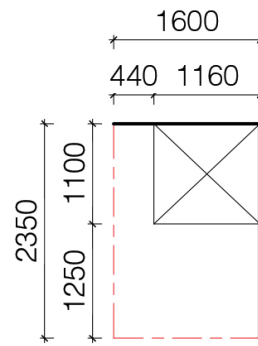
**Figure 8 (a) Circulation space for Accessible toilet in Fully Accessible and High Physical Support design categories**



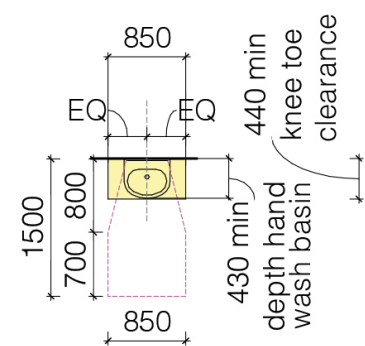
**Figure 8 (b) Optional Circulation space for Peninsular type toilet in High Physical Support design category**



**Figure 8 (c) Option 1 - Circulation space for Accessible shower**



**Figure 8 (d) Option 2 - Circulation space for Accessible shower**



**Figure 8 (e) Circulation space for Accessible basin**

**Figure 8 - Circulation space requirements for Fully Accessible and High Physical Support design categories**

Notes:

- Unless a range of dimensions is specified, all dimensions noted in the figures are the minimum required and in millimetres.
- Circulation spaces for WC pan, shower and hand wash basin shall be as per AS1428.1.
- Yellow section in Figure 8 (e) indicates encroachment-free knee and toe clearance space as per AS1428.1 under the basin for a minimum width of 850mm, centred on the hand wash basin.

**LEGEND**



Improved Liveability



Robust



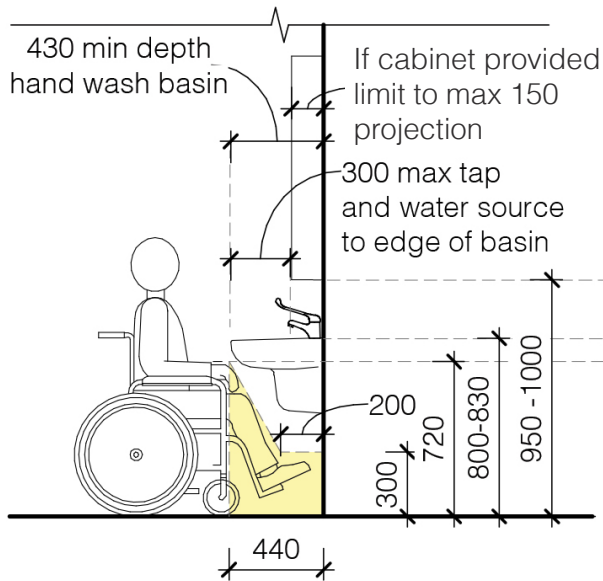
Fully Accessible



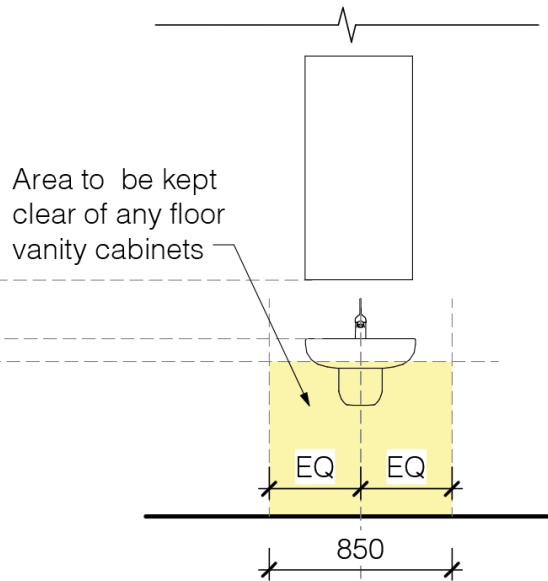
High Physical Support







**Figure 9 (a) Fixtures associated with hand wash basin - Side elevation**



**Figure 9 (b) Fixtures associated with hand wash basin - Front elevation**

**Figure 9 - Fixture requirements for Fully Accessible and High Physical Support design categories**

General Notes:

- Unless a range of dimensions is specified, all dimensions noted in the figures are the minimum required and in millimetres.

Notes in relation to Figures 9 (a) and 9 (b) - Fixtures associated with hand wash basin:

- Basin and lever mixer tap shall comply with requirements of AS1428.1.
- Wall cabinet, if provided above a hand wash basin, to have a maximum projection of 150mm and base wall cabinet to be between 950mm to 1000mm from FFL.
- Wall cabinet can be provided either above or beside the basin.
- Basin depth shall be minimum of 430mm.
- Yellow sections indicate encroachment-free knee and toe clearance space as per AS1428.1. under the basin for a minimum width of 850mm, centred on the hand wash basin.

**LEGEND**



Improved Liveability



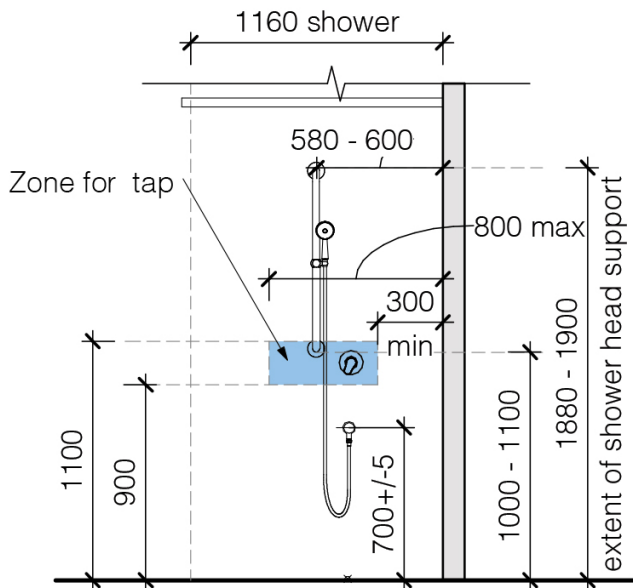
Robust



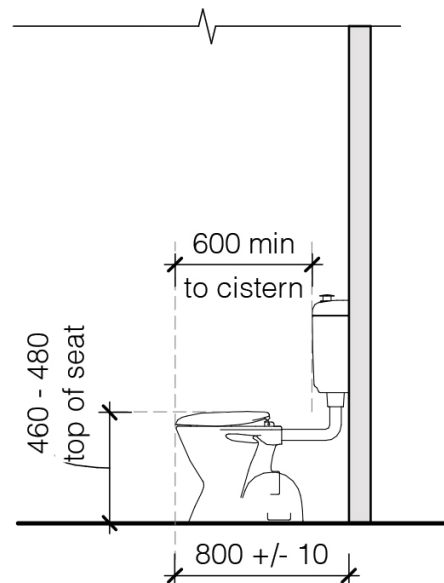
Fully Accessible



High Physical Support



**Figure 9 (c) Fixtures associated with shower**



**Figure 9 (d) Set out of Accessible WC pan**

**Figure 9 - Fixture requirements for Fully Accessible and High Physical Support design categories (continued)**

General Notes:

- Unless a range of dimensions is specified, all dimensions noted in the figures are the minimum required and in millimetres.

Notes in relation to Figure 9 (c) - Fixtures associated with shower:

- Only vertical grabrail shall be provided with height adjustable shower head and hose as per AS1428.1.
- Taps shall be located in a zone between 900mm and 1100mm above FFL and at a minimum of 300mm and maximum of 800mm from internal corner.
- Any type of floor drain including strip drain is permitted to adequately drain the shower floor.
- Provide shower curtain rail.
- Shower seat and horizontal grabrail shall not be provided unless specifically required by the participant.

Notes in relation to Figure 9 (d) - Fixtures associated with WC pan:

- WC pan shall be AS1428.1 compliant (as per requirements for accessible unisex toilet and not as per ambulant toilet).
- Backrests and grabrails shall not be provided, unless specifically required by the participant.

**LEGEND**



Improved Liveability



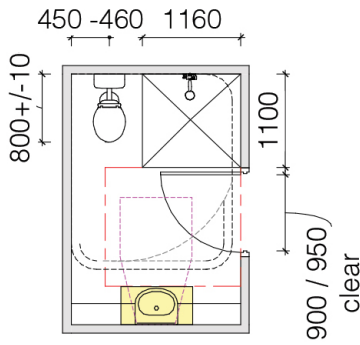
Robust



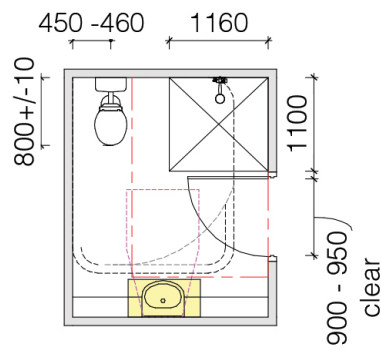
Fully Accessible



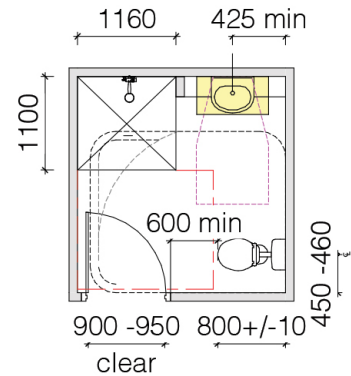
High Physical Support



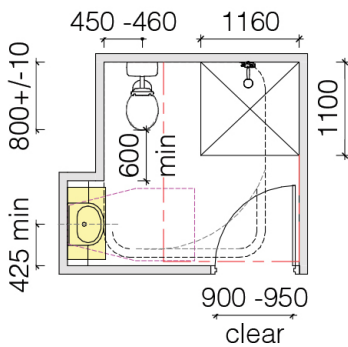
**Figure 10 (a) Bathroom Design Option 1**



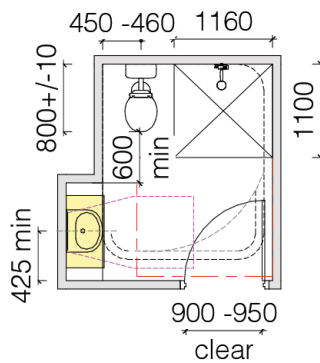
**Figure 10 (b) Bathroom Design Option 2**



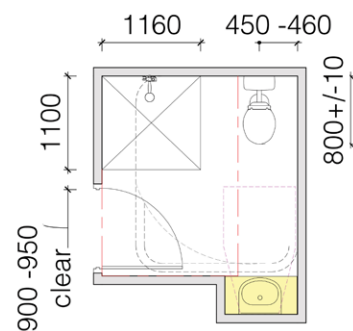
**Figure 10 (c) Bathroom Design Option 3**



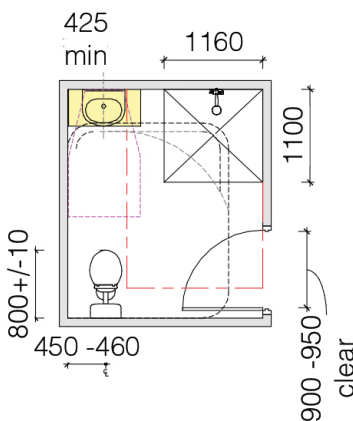
**Figure 10 (d) Bathroom Design Option 4**



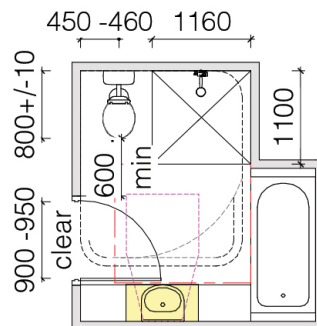
**Figure 10 (e) Bathroom Design Option 5**



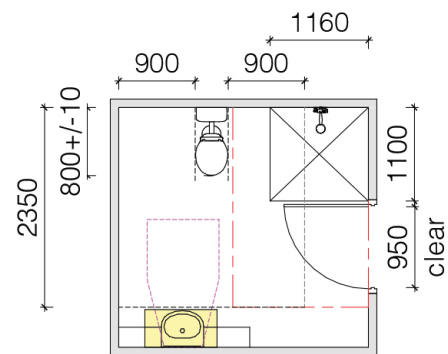
**Figure 10 (f) Bathroom Design Option 6**



**Figure 10 (g) Bathroom Design Option 7**



**Figure 10 (h) Bathroom Design Option 8**



**Figure 10 (i) Bathroom Design Option 9 (only for High Physical Support design category)**

**Figure 10 - Sample designs for Fully Accessible and High Physical Support design categories**  
(see notes next page)

**LEGEND**



Improved Liveability



Robust



Fully Accessible

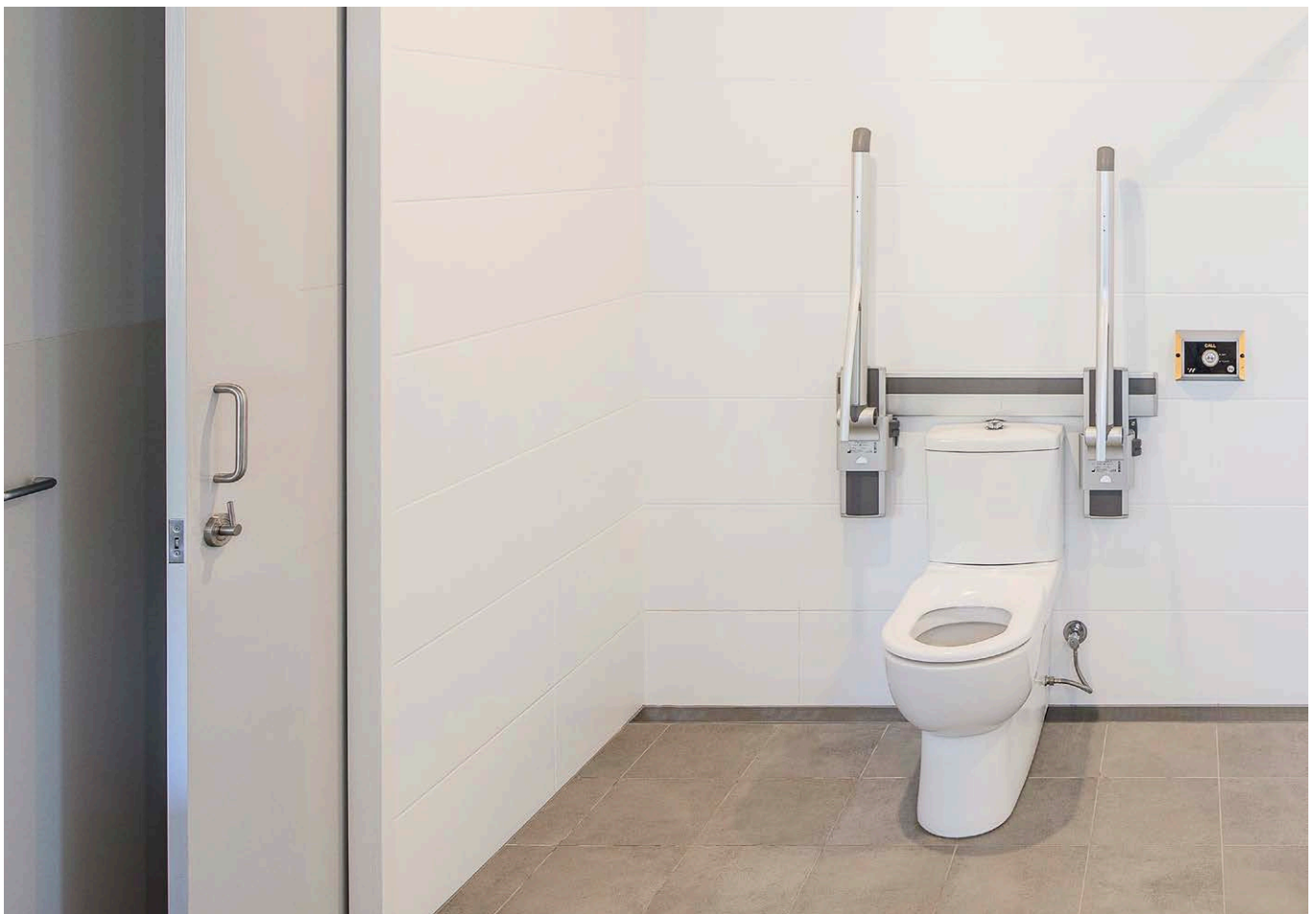


High Physical Support

## Figure 10 - Sample designs for Fully Accessible and High Physical Support design categories (continued)

Notes:

- Unless a range of dimensions is specified, all dimensions noted in the figures are the minimum required and in millimetres.
- Circulation spaces for WC pan, shower and hand wash basin shall be as per AS1428.1 (for wheelchair accessibility).
- Selection of WC pan, basin and taps shall be as per AS1428.1.
- Use of shower screens is not permitted.
- Doors to provide 900mm or 950mm clear opening depending on the design category.
- Doors to provide door circulation spaces (internal as well as external to bathroom) as per AS1428.1.
- In designs where the nearside wall adjacent to the WC pan includes a doorway (and wall is not available on the other side of the WC pan, for example Figure 10(c)) or where the nearside wall adjacent to the WC pan includes a return wall (for example Figure 10(d)) then a 600mm minimum length reinforced wall shall be provided.
- Internal side of full sanitary facility shall have wall reinforcement which consists of minimum 12mm thick sheeting, from FFL and extending to a height of minimum 2100mm from FFL.



### LEGEND



Improved Liveability



Robust











Fully Accessible



High Physical Support

## 7.2 Wall reinforcements to sanitary compartments

Clause	Design Requirement	Rationale	Applicable to
7.2.1	Except for walls constructed of masonry or concrete, the internal side of the full sanitary room with the required WC pan, shower, hand wash basin and fixed bathtub (if provided) shall have wall reinforcement of minimum 12mm thick sheeting, from FFL and extending to a height of minimum 2100mm from FFL.	<p>For future proofing, if grabrails are required.</p> <p>Note: Sheeting is required to be of a material such as plywood or compressed fibre cement. The sheeting of foam board or an insulation panel is not permitted.</p>	   
7.2.2	<p>The WC pan shall have an adjacent side wall (on at least one side of the WC pan) with a 600mm minimum length of wall reinforcement, forward of the WC pan.</p> <p>In designs where the nearside wall adjacent to the WC pan includes a doorway (and the wall is not available on the other side of the WC pan) then a 600mm minimum length reinforced wall shall be clear of the door frame.</p>	<p>Required for locating future grabrails. Refer to Figures 7(a) and 7(f) for examples.</p> <p>Note: This requirement does not apply when a peninsular type WC pan is provided for High Physical Support design category.</p>	   

### LEGEND



Improved Liveability



Robust















Fully Accessible



High Physical Support

## 8. Kitchen

Clause	Design Requirement	Rationale	Applicable to
8.1	A kitchen shall be provided with the following minimum fixtures: a fixed cooktop (with a rangehood), an in-built oven, a sink (with tap) and a dishwasher.		   
8.2	<p>At least 1000mm clearance shall be provided in front of fixed benches and appliances (being the leading edge of the outermost bench and not from the face of cupboards or the kickplate and excluding handles).</p> <p>Where the appliances are not installed, the recessed area provision for an appliance shall be a minimum of 700mm in depth.</p>	<p>1000mm space between benches has been specified for the comfort of users.</p> <p>Refer to Figure 11 for details.</p>	 
8.3	<p>At least 1550mm clearance shall be provided in front of fixed benches and appliances (being the leading edge of the outermost bench and not from the face of cupboards or the kickplate and excluding handles).</p> <p>Where the appliances are not installed the recessed area provision for an appliance shall be a minimum of 700mm in depth.</p>	<p>1550mm space between benches has been specified for the comfort of persons using wheelchairs.</p>	 
8.4	<p>Task lighting shall be provided above workspaces. A minimum level of 300lux shall be achieved when tested at maximum intervals of 1500mm, directly over the surface of the benchtops.</p>	<p>For good visibility.</p>	   

### LEGEND



Improved Liveability





Robust





Fully Accessible







High Physical Support





Clause	Design Requirement	Rationale	Applicable to
8.5	<p>A wall oven shall be provided with features as noted below:</p> <ul style="list-style-type: none"> <li>• Side hinged door with latch side of door next to accessible benchtop.</li> <li>• At least a part of the operable part of oven door handle shall be located between 600mm and 1100mm above the FFL.</li> <li>• At least one shelf on telescopic rails within the oven.</li> </ul>	Access to oven to be such that it can be used in seated or standing position.	 







LEGEND	 Improved Liveability	 Robust	 Fully Accessible	 High Physical Support
--------	--	--	--	---



Clause	Design Requirement	Rationale	Applicable to
8.6	<p>An accessible benchtop shall be provided with features as noted below:</p> <ul style="list-style-type: none"> <li>A benchtop surface of minimum 600mm depth shall be provided right next to the cooktop and wall oven (on the latch side of the oven door).</li> <li>This accessible benchtop shall provide a minimum space of 900mm (width) x 440mm (depth) clear of any fixtures other than what is permitted under knee / toe requirements of AS1428.1 under the benchtop.</li> </ul>	Refer to item 3 in Figure 12 for details.	 
8.7	<p>One height-adjustable benchtop surface, of 600mm depth, shall be provided with features as noted below:</p> <ul style="list-style-type: none"> <li>A minimum space of 900mm (width) x 440mm (depth) clear of any fixtures other than what is permitted under knee / toe requirements of AS1428.1 under the benchtop.</li> <li>Height adjustment capability from 720mm clear space underneath height adjustable benchtop till 1020mm clear space underneath height adjustable benchtop (from FFL).</li> </ul>	Note: The accessible benchtop can be designed as a height-adjustable benchtop (Refer to Option 1 in Figure 12), or another section of the benchtop can be designed as a height adjustable benchtop (Refer to Option 2 in Figure 12).	 

LEGEND	 Improved Liveability	 Robust	 Fully Accessible	 High Physical Support
--------	--	--	--	---

Clause	Design Requirement	Rationale	Applicable to
8.8	<p>Types of appropriate mechanisms for operation of kitchen cabinetry shall be one or more of the options as noted below:</p> <ul style="list-style-type: none"> <li>• D pull cupboard handles located towards the top of below-bench cupboards;</li> <li>• D pull cupboard handles located towards the bottom of overhead cupboards;</li> <li>• Overhanging lip of minimum 20mm for overhead cupboards;</li> <li>• Push to release mechanisms for both overhead and below-bench cupboards.</li> </ul>	<p>Design feature enables participant to operate in a seated or standing position with limited hand and finger movement and dexterity.</p> <p>Drawers under the benchtop are preferred to the cupboards.</p>	
8.9	<p>A cooktop shall be provided with features as noted below:</p> <ul style="list-style-type: none"> <li>• Either electric or induction</li> <li>• Shall be located at least 300mm from any internal corner or wall, excluding the splashback.</li> </ul>	<p>Electric /or induction cooktop is considered to be safer than gas cooktop.</p>	
8.10	<p>The cooktop controls shall be on the side of the accessible benchtop or near the front edge of the benchtop.</p>		
8.11	<p>Lever or sensor type tapware shall be provided to sink to comply with AS1428.1 and shall be located such that the operable parts of the lever tap and water source is not more than 300mm from the edge of benchtop.</p>		

**LEGEND**



Improved Liveability
















Robust

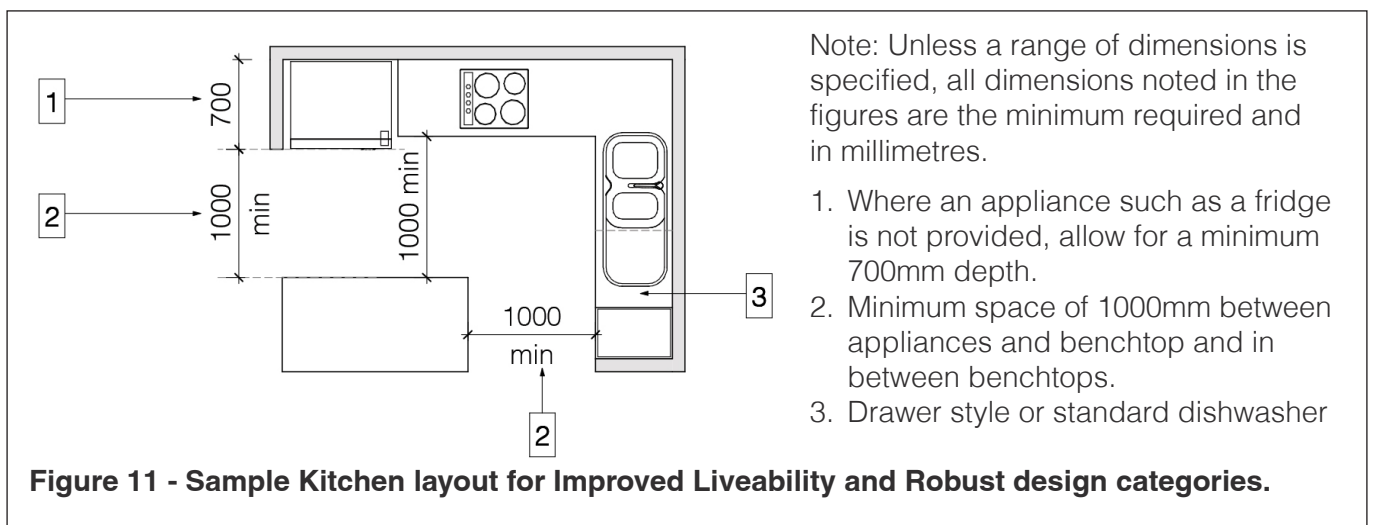






Fully Accessible



High Physical Support

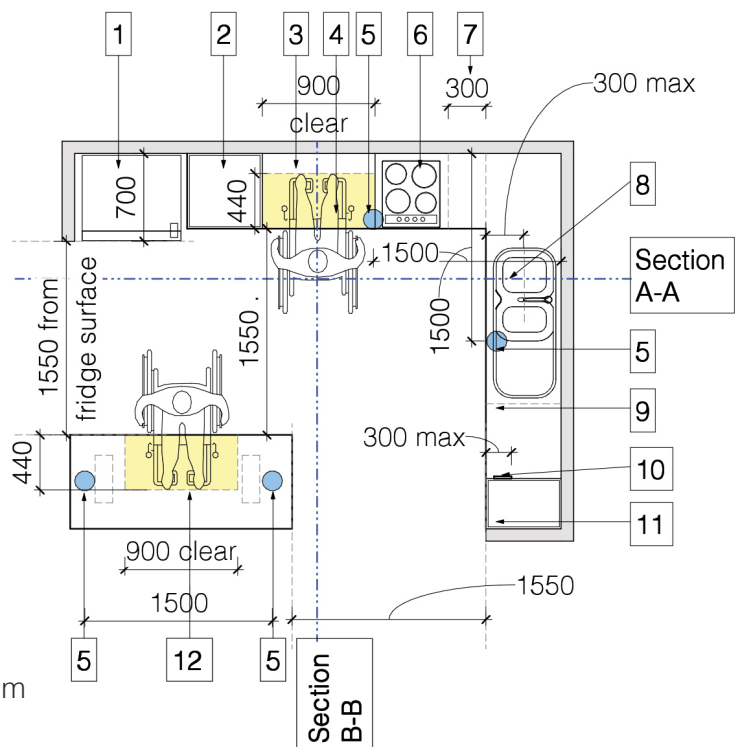
Clause	Design Requirement	Rationale	Applicable to
8.12	At least one double GPO shall be provided within 300mm from the front edge of the benchtop (from the edge within the kitchen area) and max height of 1100mm from FFL. GPO shall be located adjacent to a bench of minimum 600mm depth.	Enables appliances such as toasters, kettles, and sandwich presses to be used.	 
8.13	Standard or drawer style dishwasher shall be provided.	Included for improved amenity.	 
8.14	Drawer style dishwasher shall be provided.	Design feature enables participant to operate in a seated or standing position.	 
8.15	A pantry shall be provided which is wheelchair accessible.	Required for ease of use. Pantry with extendable basket type shelves or full pull out style pantry is considered to be suitable.	 
8.16	Kitchen benchtop and cabinetry shall be made of robust materials.	Required for safety of users.	
8.17	Slip resistance of all kitchen flooring shall be minimum of P3 or R10.		   



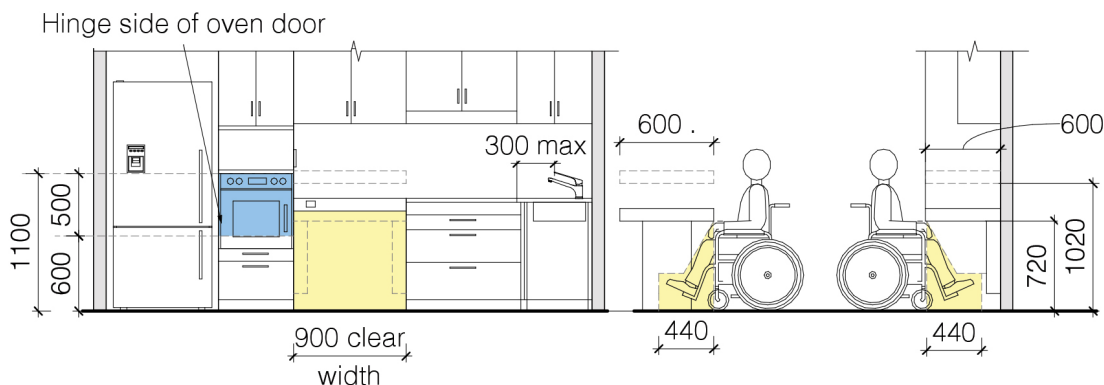
LEGEND	 Improved Liveability	 Robust	 Fully Accessible	 High Physical Support
--------	--	--	--	---



1. Where an appliance such as a fridge is not provided, allow for a minimum 700mm depth.
2. Provide wall oven with side hinge door.
3. Location of accessible benchtop next to wall oven and next to cooktop with 900mm clear width under the benchtop with knee / toe clearances as per AS1428.1
4. Option 1 - Location of height adjustable benchtop.
5. Test locations for minimum 300lux lighting levels at maximum intervals of 1500mm measured directly over the benchtops.
6. Cooktop controls on side of accessible benchtop or at front edge of the benchtop.
7. Cooktop shall be either electric or induction and shall be located a minimum of 300mm from any internal corner.
8. Operable part of lever tap handle and water source shall be within 300mm from edge of benchtop.
9. Drawer style dishwasher.
10. Double GPO shall be within 300mm from the edge of the benchtop and maximum height of 1100mm from FFL.
11. Pantry with extendable basket shelves or full pullout style pantry.
12. Option 2 - Location of height adjustable benchtop. Note: Height adjustable benchtop to have height adjustment from 720mm clear space underneath height adjustable benchtop till 1020mm clear space underneath height adjustable benchtop and be provided with 900mm clear width under the benchtop with knee toe clearances as per AS1428.1 (as required for hand wash basins).



**Figure 12 Sample Plan of Kitchen layout for Fully Accessible and High Physical Support design categories**



**Figure 13 (a) Section A - A**

**Figure 13 (b) Section B - B**

**Figure 13 - Sample Sectional Elevations of Kitchen layout for Fully Accessible and High Physical Support design categories**

Note: Unless a range of dimensions is specified, all dimensions noted in the figures are the minimum required and in millimetres.

**LEGEND**



Improved Liveability



Robust






Fully Accessible



High Physical Support

## 9. Laundry

Clause	Design Requirement	Rationale	Applicable to
9.1	<p>A laundry shall be provided with the following minimum fixtures: a sink or tub (with taps).</p> <p>Laundry could be a shared laundry and not necessarily located within the dwelling.</p>	<p>Accessible path of travel is required from the dwelling to the laundry. This accessible path is required to comply with all the spatial requirements based on the design category.</p>	
9.2	<p>At least 1000mm clearance shall be provided in front of fixed benches and appliances (being the leading edge of the outermost bench and not from the face of cupboards or the kickplate and excluding handles).</p> <p>Where the appliances are not installed the recessed area provision for an appliance shall be a minimum of 700mm in depth.</p>	<p>To enable minimum access to facilities.</p> <p>Depth of appliance 700mm is specified based on available appliances.</p>	
9.3	<p>At least 1550mm clearance shall be provided in front of fixed benches and appliances (being the leading edge of the outermost bench and not from the face of cupboards or the kickplate and excluding handles).</p> <p>Where the appliances are not installed the recessed area provision for an appliance shall be a minimum of 700mm in depth.</p>	<p>To enable turn around in laundry. Depth of appliance 700mm is specified based on available appliances.</p>	

### LEGEND



Improved Liveability









Robust







Fully Accessible



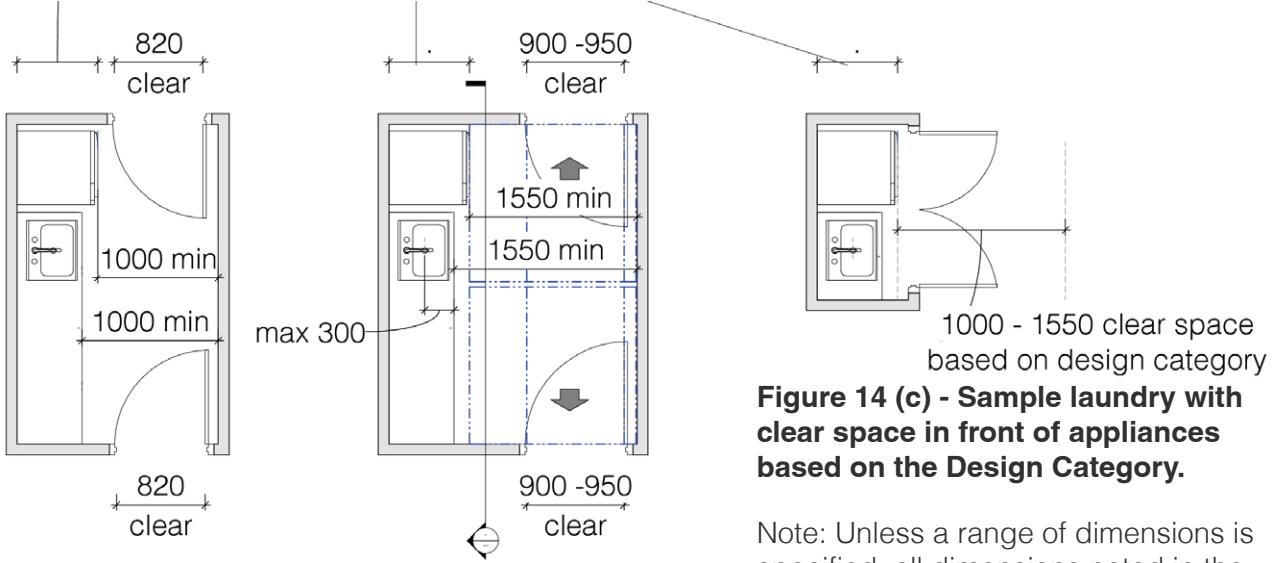
High Physical Support

Clause	Design Requirement	Rationale	Applicable to
9.4	Basins, sinks and tubs shall be provided with sensor type or lever style tap. The tap shall be located such that the operable parts of the lever tap and water source is not more than 300mm from the edge of benchtop/ laundry tub trough / bench.	For ease of operation for all users.	 
9.5	Slip resistance of all laundry flooring shall be a minimum of P3 or R10.		   



LEGEND	 Improved Liveability	 Robust	 Fully Accessible	 High Physical Support
--------	--	--	--	---

Where appliances such as washing machine / dryer are not provided, allow for min 700 space for the same.



**Figure 14 (a) - Sample laundry layout for Improved Liveability and Robust design categories**

**Figure 14 (b) - Sample laundry layout for Fully Accessible and High Physical Support design categories**

**Figure 14 (c) - Sample laundry with clear space in front of appliances based on the Design Category.**

Note: Unless a range of dimensions is specified, all dimensions noted in the figures are the minimum required and in millimetres.

Door sizes shall be provided as required by the design category.

**Figure 14 - Sample Laundry designs based on the Design category**

**LEGEND**



Improved Liveability



Robust



Fully Accessible









High Physical Support



## 10. Bedroom

Each Participant shall be provided with a bedroom based on their SDA design category.

Clause	Design Requirement	Rationale	Applicable to
10.1	<ul style="list-style-type: none"> <li>Bedroom size shall be 3100mm x 3100mm when measured from wall surface to wall surface.</li> <li>A robe of minimum 1400mm width shall be provided within the bedroom, clear of the required bedroom size.</li> </ul>	<p>Bedroom size dimensions are not required to be measured from skirting to skirting.</p> <p>The 1400mm width robe can have multiple smaller sections within the one 1400mm space.</p> <p>Refer to Figure 15 for details.</p>	 
10.2	<ul style="list-style-type: none"> <li>Bedroom size shall allow for a minimum Queen bed of size 1530mm x 2100mm.</li> <li>Circulation spaces around the three sides of the bed (not including bed head side) shall include:               <ul style="list-style-type: none"> <li>Space with minimum width of 1540mm on any one side on the bed;</li> <li>Space with minimum width of 1000mm to the other two sides of the bed.</li> </ul> </li> </ul>	<p>An Australian Queen size mattress is 1530mm x 2030mm, and therefore a minimum Queen bed size of 1530mm x 2100mm is to be provided for. Bedroom size dimensions can be measured from wall surface to wall surface (not required to be measured from skirting to skirting).</p> <p>Refer to Figures 17 and 18 for details.</p>	 
10.3	<p>The following door circulation spaces for bedroom shall be provided:</p> <ul style="list-style-type: none"> <li>Internal door circulation space of the door to bedroom shall be a minimum of 1540mm (width) and 1450mm (depth), as shown in Figure 16. This internal door circulation space shall be clear of the Queen bed of size 1530mm x 2100mm.</li> <li>External door circulation space shall be as per AS1428.1 based on the direction of approach or a minimum of 1200mm when measured from skirting to skirting (whichever is more).</li> </ul>	<p>Ideally the internal door circulation spaces should be as per AS1428.1, clear of the bed, based on the direction of travel. To enable a reasonable level of access, the circulation space of 1540mm x 1450mm is considered to be suitable as long as it is clear of the required size of the Queen bed as demonstrated in Figures 17 and 18.</p>	 

### LEGEND



Improved Liveability







Robust



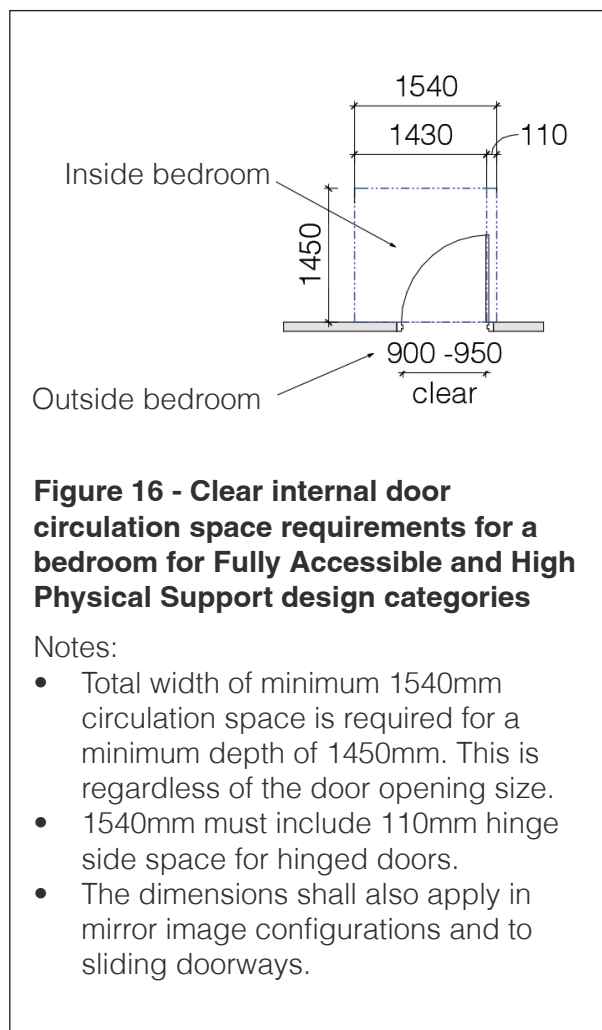
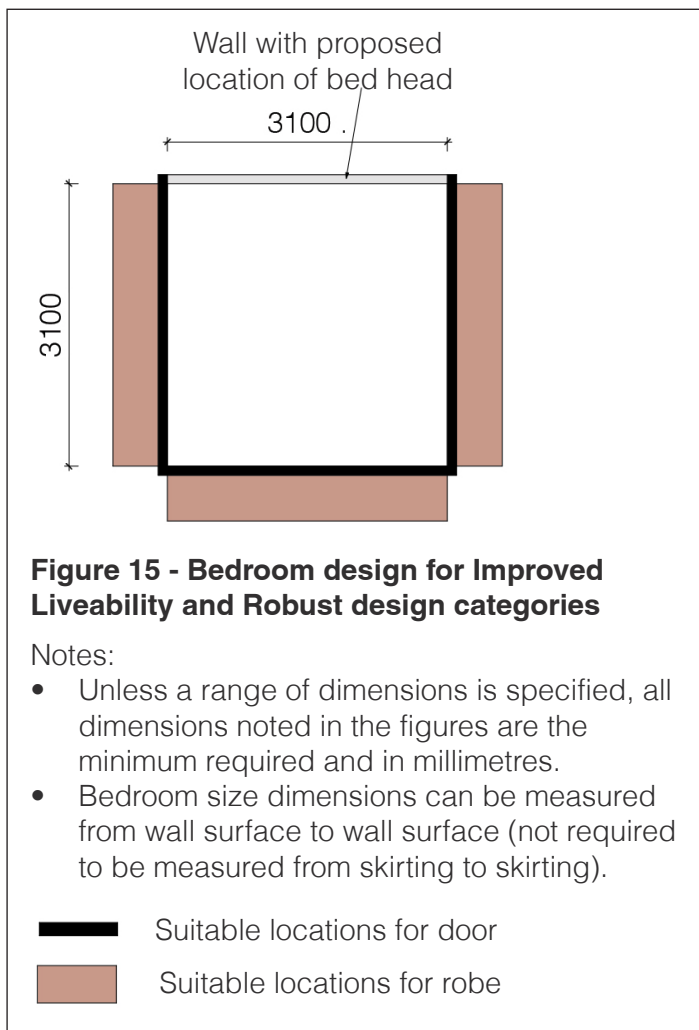
Fully Accessible

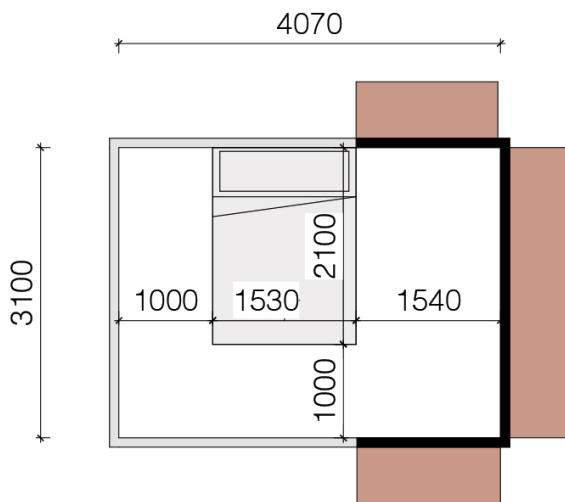


High Physical Support

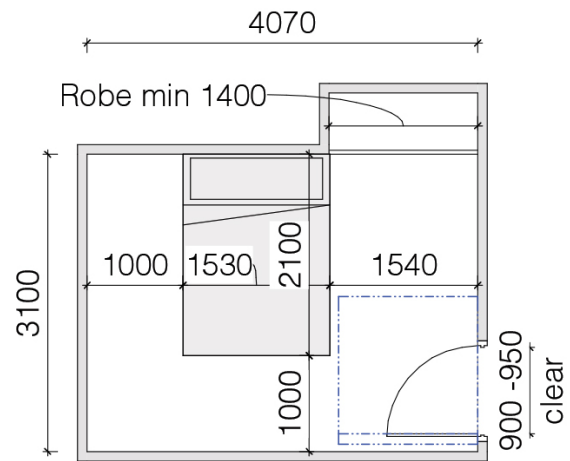
Clause	Design Requirement	Rationale	Applicable to
10.4	A robe of 1400mm width shall be provided within the bedroom, clear of the required bedroom size and with a minimum space of 1540mm in front of the robe.	The 1400mm width robe can have multiple smaller sections within the one 1400mm space.	 
10.5	<p>Following GPOs shall be provided:</p> <ul style="list-style-type: none"> <li>• Three double GPO on the wall where the head of the bed is likely to be, and</li> <li>• At least one double GPO on the wall opposite the wall where the head of the bed is likely to be.</li> </ul>		 

Note: Ceiling hoist requirements for bedrooms are noted in the Ceiling hoist section.

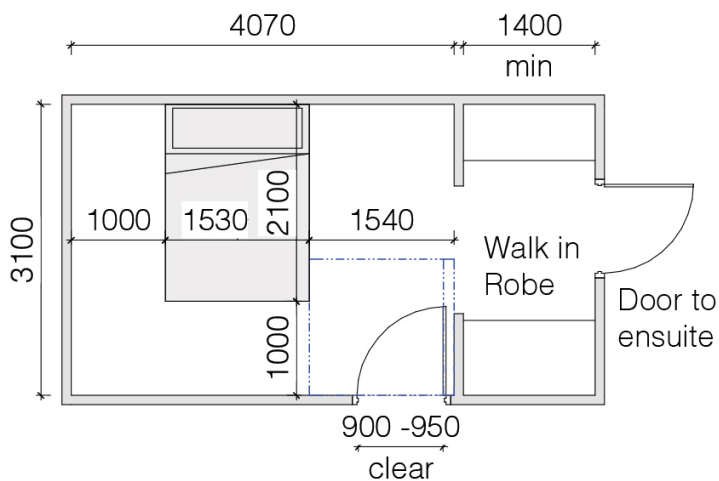




**Figure 17 (a) Option 1 - Transfer position on side of Queen bed (allow for 1530mm x 2100mm) with 1000mm space on other two sides of the bed. (Preferred option)**





**Figure 17 (b) - Sample layout based on Option 1**



**Figure 17 (c) - Sample layout based on Option 1**

**Figure 17 - Bedroom design Option 1 for Fully Accessible and High Physical Support design categories**

-  Suitable locations for door
-  Suitable locations for robe

- Minimum internal door circulation space of door to bedroom shall be as per Figure 16. This space shall be clear of required Queen bed size of 1530mm x 2100mm and any internal robes.
- The external door circulation space of the bedroom door shall be as per AS1428.1 based on the direction of approach or a minimum of 1200mm when measured from skirting to skirting (whichever is more).
- Bedroom size dimensions can be measured from wall surface to wall surface (not required to be measured from skirting to skirting).

**LEGEND**



Improved Liveability



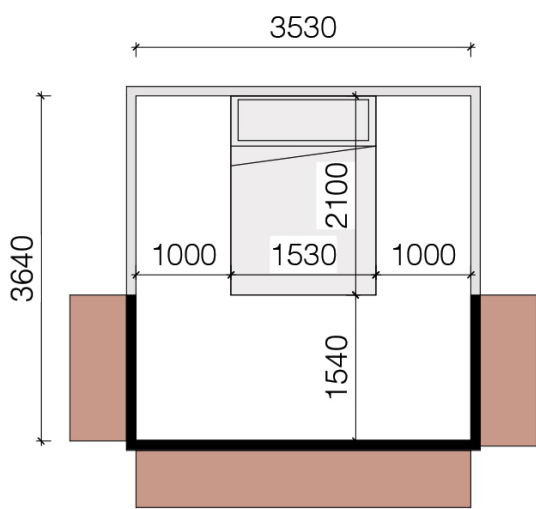
Robust



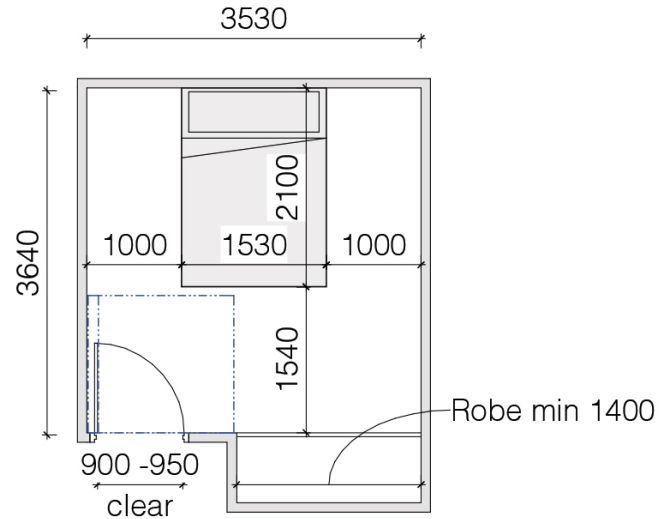
Fully Accessible



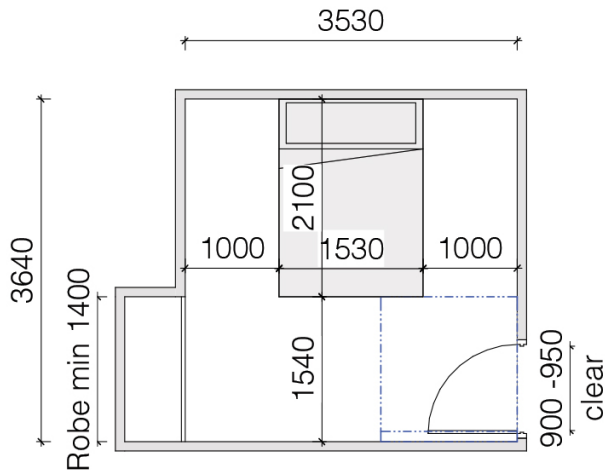
High Physical Support



**Figure 18 (a) Option 2 - Transfer position on base of Queen bed (allow for 1530mm x 2100mm) with 1000mm space on other two sides of the bed.**





**Figure 18 (b) - Sample layout based on Option 2**



**Figure 18 (c) - Sample layout based on Option 2**

**Figure 18 - Bedroom design Option 2 for Fully Accessible and High Physical Support design categories**

-  Suitable locations for door
-  Suitable locations for robe

- Minimum internal door circulation space of door to bedroom shall be as per Figure 16. This space shall be clear of required Queen bed size of 1530mm x 2100mm and any internal robes.
- The external door circulation space of the bedroom door shall be as per AS1428.1 based on the direction of approach or a minimum of 1200mm when measured from skirting to skirting (whichever is more).
- Bedroom size dimensions can be measured from wall surface to wall surface (not required to be measured from skirting to skirting).

**LEGEND**



Improved Liveability



Robust





Fully Accessible



High Physical Support

## 11. Living area

Clause	Design Requirement	Rationale	Applicable to
11.1	The family/living room shall accommodate a free space, minimum 2250mm in diameter, clear of furniture.	Provided to enable ease of movement clear of furniture.	 



### LEGEND



Improved Liveability



Robust

















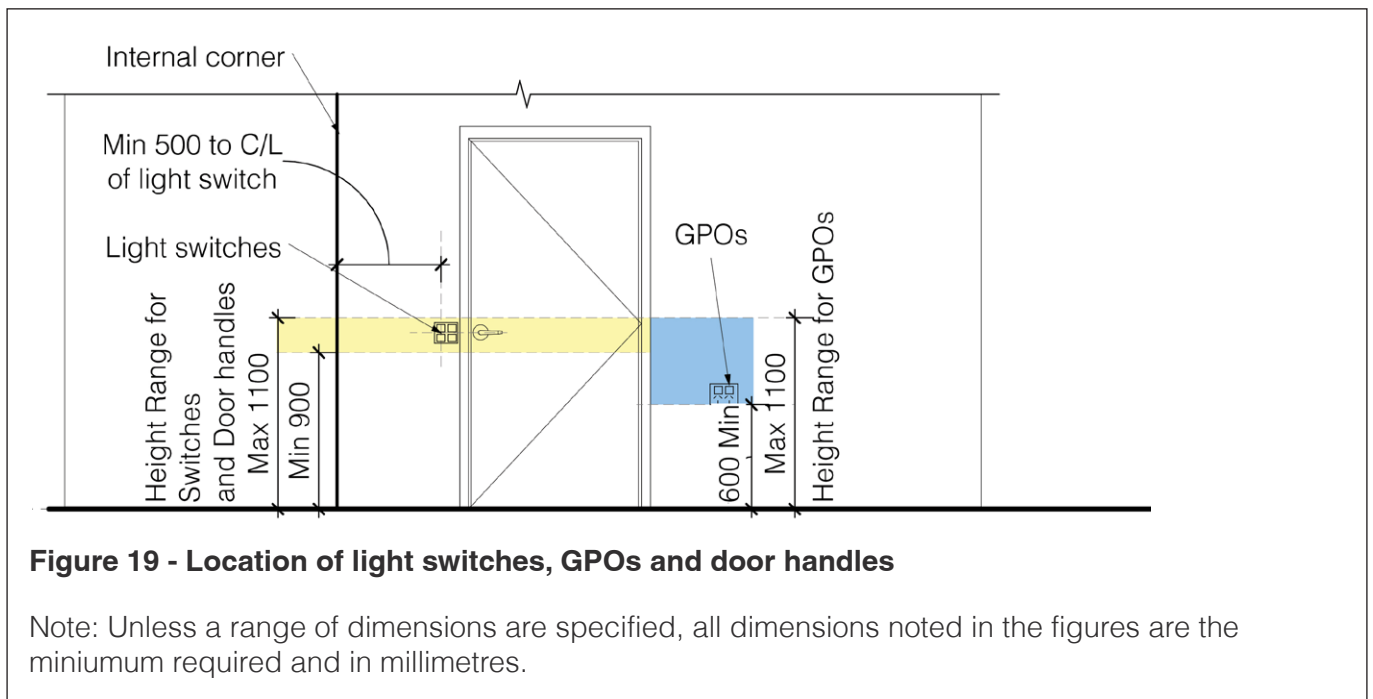
Fully Accessible



High Physical Support

## 12. Switches and powerpoints

Clause	Design Requirement	Rationale	Applicable to
12.1	<p>Light switches shall be positioned in a consistent location:</p> <ul style="list-style-type: none"> <li>Between 900mm – 1000mm above the FFL, and</li> <li>Horizontally aligned with the door handle at the entrance to a room.</li> </ul>	For ease of access and consistency of locations.	   
12.2	GPOs shall be installed between 600mm and 1100mm above the FFL.	For ease of access by user.	 
12.3	Light and GPO switches shall be rocker action, toggle or push pad in design with a minimum width of 35mm.	For ease of access by user.	   
12.4	Dimmable lighting switches shall be provided in living areas and bedrooms.	For comfort level selections. Provision of standard type rotary dimmer controls will satisfy this requirement.	   



### LEGEND



Improved Liveability



Robust













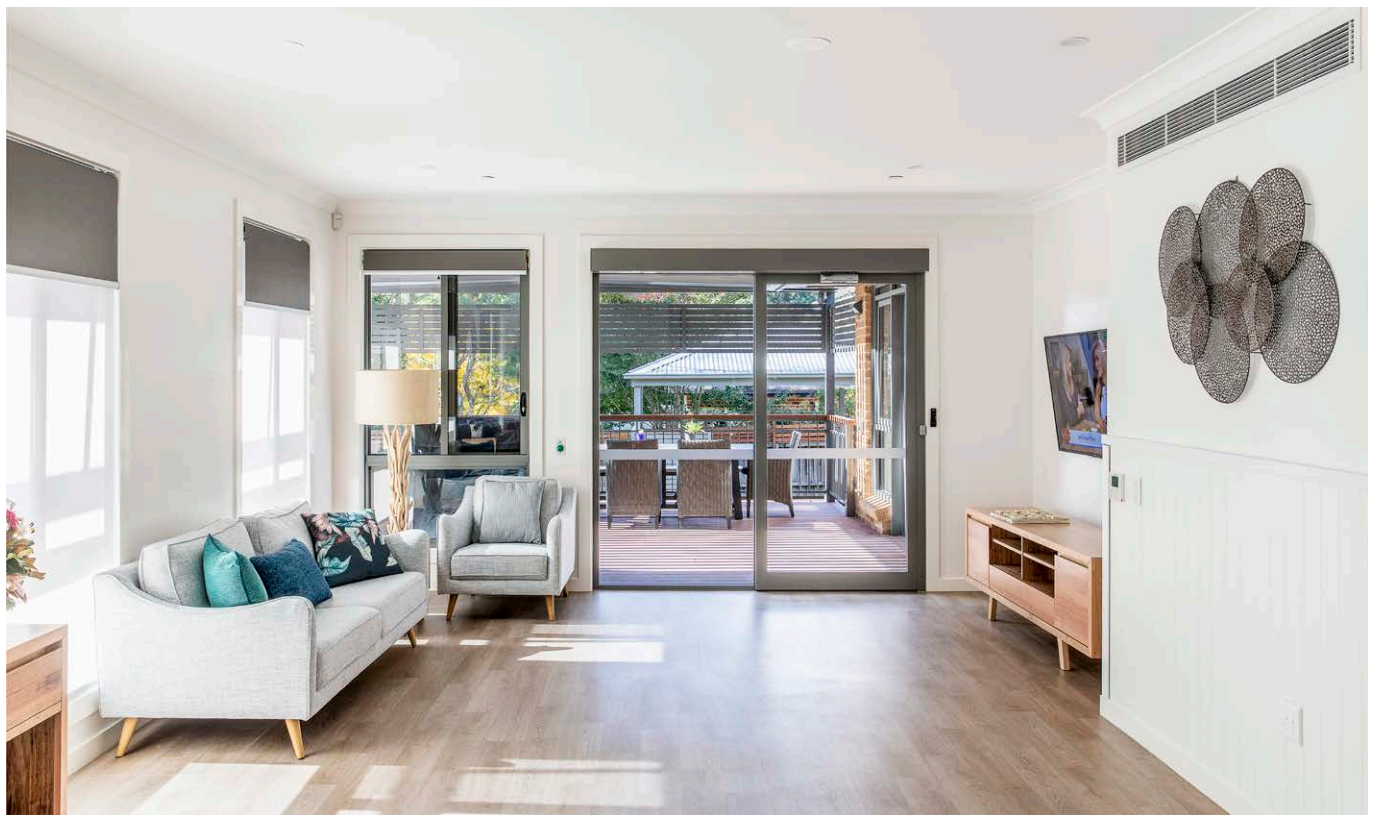
Fully Accessible







High Physical Support

### 13. Flooring and slip resistance





















Clause	Design Requirement	Rationale	Applicable to
13.1	All internal flooring (including wet areas) shall be firm, even and feature a level transition between abutting surfaces of a maximum vertical tolerance of 3mm or 5mm (provided the lip is rounded or bevelled).	For safety of users.	   
13.2	All internal floor finishes shall have a minimum slip resistance of P3 or R10.	For safety of users. Additional slip resistance is required for internal stairways.	   
13.3	Carpets if provided within the dwelling, shall be provided with pile height or thickness not more than 11mm and carpet backing not more than 4mm bringing the total height to a maximum of 15mm.	To assist persons that require use of a wheelchair for mobility. Note that attention should be provided to the density of the carpet and the quality of the underlay which may make floor unsuitable for wheelchairs regardless of the pile height of the carpet.	 



LEGEND	 Improved Liveability	 Robust	 Fully Accessible	 High Physical Support
--------	--	--	--	---

## 14. Internal stairways

It is assumed that access will be available to all internal areas of the Robust, Fully Accessible and High Physical support design category dwellings either by provision of all facilities on the entry level or by means of lifts. It is considered to be reasonable to provide bedrooms for Improved Liveability design category on a level that has access only via steps. In addition to the lifts, any stairways provided in the dwellings are required to comply with the requirements of Clause 14.

Clause	Design Requirement	Rationale	Applicable to
14.1	Stairways within dwellings shall feature a continuous handrail on both sides of the stairway.	For safety of users.	   
14.2	A minimum clear width of 1000mm shall be provided; between the handrails and handrail profile and handrail extensions shall be as per AS1428.1.	For support while using the stairway.	   
14.3	Stairway shall have no winders on landings.	Easier to navigate.	   
14.4	Stairway shall have closed risers.	For safety of users.	   
14.5	The stairway shall provide slip resistance of P3 or R10.	For safety of users.	   

Notes:

- Provide nosing strips to the stairways as per AS1428.1 only where required by the NCC.
- TGSIs should only be provided if specifically required by the participants.
- Where the NCC mandates use of TGSIs, consideration to be given to their removal by means of a BCA Performance Solution of handrails having a raised tactile warning indicators, in the form of a domed button 4 mm to 5 mm in height and 10 mm to 12 mm in diameter on the top of the handrail, 150 ±10 mm from the end of the handrail.

### LEGEND



Improved Liveability



Robust















Fully Accessible



High Physical Support



## 15. Use of lifts

Clause	Design Requirement	Rationale	Applicable to
15.1	Passenger lift if provided within a dwelling or for access to a dwelling shall be as permitted under the NCC Clause E3.6, excluding the use of stairway platform lifts.	Provided to promote innovation and flexibility of design, especially developments in smaller plot sizes.	   
15.2	Lift door to provide a minimum clear opening of 900mm.		   
15.3	The lift car size shall be minimum 1100mm (width) x 1400mm (in direction of travel).		   

### LEGEND



Improved Liveability



Robust











Fully Accessible



High Physical Support

## 16. Common use external areas, private open space and landscaping

Clause	Design Requirement	Rationale	Applicable to
16.1	All common use external stairways shall comply with AS1428.1.	<p>Provide nosing strips to the stairways as per AS1428.1 only where required by the NCC.</p> <p>TGSIs should only be provided if specifically required by the participants.</p> <p>Where the NCC mandates use of TGSIs, consideration to be given to their removal by means of a BCA Performance Solution of handrails having a raised tactile warning indicators, in the form of a domed button 4 mm to 5 mm in height and 10 mm to 12 mm in diameter on the top of the handrail, 150 ±10 mm from the end of the handrail.</p>	   
16.2	<p>Where individual letter boxes have been provided then, they shall be:</p> <ul style="list-style-type: none"> <li>Situated on a hard-standing area of 1540mm x 2070mm and have a gradient and crossfall directly in front which is less than 1:40 in any direction.</li> <li>Shall have wheelchair access by a continuous accessible path of travel from the dwelling to the letterbox,</li> <li>Shall be lockable,</li> <li>The height of the letterbox shall be between 600mm and 1100mm above FFL.</li> </ul>	To be suitable and reachable for all potential users. A concession can be applied for height requirements for letterboxes in a residential flat building.	 
16.3	All ramps and accessways provided to all external common use and external private use areas shall comply with the requirements of ramps and accessways as noted in Clauses 2.4 to 2.12 as applicable to the various design categories.		   

### LEGEND



Improved Liveability



Robust







Fully Accessible



High Physical Support

## 17. Storage

Clause	Design Requirement	Rationale	Applicable to
17.1	A dwelling shall be provided with a storage cupboard with a minimum 600mm width and adjustable shelf heights.	<p>Required for improved amenity.</p> <p>Note: The storage cupboard is required to be separate to the bedroom robe.</p> <p>In a Robust design category, it would be reasonable to provide fixed shelves.</p>	   



### LEGEND



Improved Liveability



Robust




Fully Accessible



High Physical Support

## 18. Breakout room

Clause	Design Requirement	Rationale	Applicable to
18.1	<p>If a breakout room is provided, it shall be a separate room designed to respond to the individual disability-related needs of the participant.</p> <p>It is not a study or living/ dining area but is intended to be dedicated and used to enhance learning, exploration or positively impact mood.</p> <p>This room would, therefore, be expected to make use of activities, equipment, sound and lighting in ways that are appropriate to the current residents.</p> <p>Note: a breakout room is not a seclusion room.</p>	<p>Provision of a breakout room is not mandatory but may be provided for some participants with specific requirements.</p>	

### LEGEND



Improved Liveability



Robust








Fully Accessible



High Physical Support

## 19. Luminance contrast requirements

Clause	Design Requirement	Rationale	Applicable to
19.1	<p>All doorways shall have a minimum luminance contrast of 30% provided between:</p> <ul style="list-style-type: none"> <li>• Door leaf and door jamb; OR</li> <li>• Door leaf and adjacent wall; OR</li> <li>• Architrave and wall; OR</li> <li>• Door leaf and architrave; OR</li> <li>• Door jamb and adjacent wall.</li> </ul> <p>The minimum width of the area of luminance contrast shall be 50 mm.</p> <p>The formula used for assessment of luminance contrast shall be the Bowman-Sapolinski equation of;  <math>125(Y2-Y1)/(Y1+Y2+25)</math>                      where Y2 is the LRV of the lighter area and Y1 is the LRV of the darker area.</p>	<ul style="list-style-type: none"> <li>• At the design stage validation of luminance contrast can be determined by applying Luminance Reflectance Values (LRVs) from paint suppliers.</li> <li>• At the final-as-built stage of SDA certification the luminance contrast can be suitably verified by measuring Luminance Reflectance Values (LRVs) with any commercially available colorimeter or luminance meter.</li> <li>• Smart phones and similar smart devices shall not be relied upon for LRV measurements.</li> </ul>	
19.2	<p>Solid (and non-translucent) contrasting glazing strip of 75mm width and between 900mm to 1000mm above FFL shall be provided for the full width of a glazed area which could be mistaken for an opening.</p>	<p>To provide identification of glazing and prevent accidental movement into it. This contrast is to be determined by the assessor based on their professional judgment.</p>	 
19.3	<p>Toilet seat shall have a minimum luminance contrast of 30% with the background (example, pan, wall or floor against which it is viewed).</p>	<p>Refer to Clause 19.1 for formula and assessment process.</p>	
19.4	<p>Colour contrast shall be provided between floor surfaces and wall surfaces.</p>	<p>Colour contrast is to be determined by the assessor based on their professional judgment.</p>	

**LEGEND**



Improved Liveability



Robust





Fully Accessible



High Physical Support

## 20. Ceiling hoists

Clause	Design Requirement	Rationale	Applicable to
20.1	Bedrooms shall have a provision for power and inbuilt structure, capable of installation of a constant charge ceiling hoist. The hoist shall be capable of going across the bed and down the bed. Min load capacity of the hoist shall be 250kg. Hoist is to be capable of being either ceiling mounted or wall mounted.	Required for some participants with specific requirements.	
20.2	Evidence / Certification document shall be provided for the building structure to be able to provide for a ceiling hoist in the future: <ul style="list-style-type: none"> <li>For design stage assessments, the notation of the requirements on the assessed drawings or specifications is adequate.</li> <li>For final-as-built stage of SDA certification, the structure shall be inspected and certified by a qualified structural engineer as being suitable for ceiling hoists with minimum load capacity of 250kg.</li> </ul>	For structural integrity of hoist provision.	

### LEGEND



Improved Liveability



Robust







Fully Accessible




High Physical Support

## 21. Heating and cooling

Clause	Design Requirement	Rationale	Applicable to
21.1	Reverse cycle air-conditioning shall be provided to living areas and bedrooms with control panels in an accessible location between 900mm and 1100mm from FFL and not closer than 500mm to any internal corner.	For participants as needed and for accessible use.	 
21.2	Where ducted air-conditioning is used, zoning of habitable rooms shall be provided.	To ensure it is suitable for participant's health needs.	 

## 22. Emergency power solutions

Clause	Design Requirement	Rationale	Applicable to
22.1	Emergency power solutions shall be provided to cater for a minimum 2-hour outage in no less than 2 double GPOs in participant bedrooms and any provided automated doors that are used for entry or egress.	Backup for life support systems if needed by participants.	

### LEGEND



Improved Liveability



Robust






Fully Accessible



High Physical Support

## 23. Assistive technology

Clause	Design Requirement	Rationale	Applicable to
23.1	Internet connection shall be provided with the ability for high internet speeds to be maintained and stable in nature with wi-fi coverage throughout all areas of the dwelling.	For best use and needs of participants.	 
23.2	A video, intercom or other communication system shall be provided to enable communication between the participant and their supports when not within line of sight.	For safe management of the dwelling. Video or intercom systems could become obsolete or superseded by newer, more portable and innovative technology. This clause therefore, provides flexibility for such a system to be provided.	



### LEGEND



Improved Liveability



Robust



Fully Accessible











High Physical Support



## 24. Fire safe design

All fire safety features shall be provided as required by the NCC based on the dwelling classification as determined by the Building Certifier.

Clause	Design Requirement	Rationale	Applicable to
24.1	Smoke alarms that are in keeping with a home environment shall be provided in bedrooms and living spaces.	Required for safety of users.	   
24.2	Emergency evacuation plan shall be provided to the occupier or their supports, which may include a path of travel to a safe place.  This is only required at final/as-built stage of SDA certification.	Required for safety of users.	   

Notes:

- Fire compartmentation may be required by the NCC.
- It is desirable for fire sprinklers to be provided.
- Note that emergency lighting to assist evacuation may also be required to be installed under the NCC
- Fire resisting walls between attached SDA Dwellings to be designed as per the requirements of the NCC.

### LEGEND



Improved Liveability



Robust








Fully Accessible



High Physical Support

## 25. Robust design

Clause	Design Requirement	Rationale	Applicable to
25.1	Resilient but inconspicuous materials shall be provided, that can withstand heavy use and minimises the risk of injury, including high impact wall lining.	For safe use of the dwelling for some users. Consider provision of high impact wall lining for the full height of the wall or a minimum of 2.4M height from FFL.	
25.2	High impact/vandal proof fittings and fixtures shall be provided (for example, commercial vandal-proof door handles).  Such fixtures and fittings shall be resilient yet inconspicuous so they uphold and do not undermine the character of the home.	For safety and serviceability for users.	
25.3	Participant's bedroom shall be sound insulated.	For privacy of users. One way of achieving this is to provide wall insulation.	
25.4	Recessed lighting fixtures shall be provided.	To prevent damage and maintain safety for users.	
25.5	Design drawings shall be provided to show layout with areas of egress and retreat for staff and other residents to avoid harm.  This is only required at final/as-built stage of SDA certification.	For safety of users. This document is to be provided to the site manager if any.	

### LEGEND



Improved Liveability



Robust



Fully Accessible



High Physical Support

# **Appendix A: General best practice recommendations**

## Appendix A: General best practice recommendations

In addition to the minimum design, some best practice recommendations are detailed below and relate to the referenced sections

Clause No	Section Title	Best Practice Recommendations
1	General Requirements	<p><b>Site Selection</b></p> <p>It is recommended that SDA dwellings be located on suitable parcels of land that provide an accessible dwelling with wheelchair accessible/usable outdoor areas without excessive use of ramping, lifts or the like. All private open space or majority of the common open space (where provided) should be wheelchair accessible.</p> <p>It is recommended to select a site in proximity to public transport. Proximity to public transport will benefit users that rely on public transport.</p> <p>For example, NSW State Environmental Planning Policy (Affordable Rental Housing) 2009 requires the site to be within 800 M walking distance of a public entrance to a railway station or a wharf; or 400M walking distance of a public entrance to a light rail station or a bus stop used by a regular bus service. A similar provision for SDA dwelling site would be advantageous for the residents.</p> <p>Since this may not be achievable for all sites, especially in rural areas, this feature is recommended but not mandatory.</p>
3	Car Parking	<ul style="list-style-type: none"> <li>Where 3800mm wide parking spaces are proposed, it is recommended to increase the length to 7800mm for mobility vehicles that use ramps at the rear of the vehicle.</li> <li>To accommodate a vehicle that uses a side ramp or a roof mounted hoist, it is recommended to provide a car parking space of width of 4800mm.</li> </ul>
6	Windows	<p>It is recommended to provide a sill height of maximum 600mm from FFL for Fully Accessible and High Physical Support design categories.</p>
7	Sanitary Facilities	<p>For all design categories:</p> <ul style="list-style-type: none"> <li>It is recommended to provide either wall cabinets or vanity cabinets for storage in the bathrooms.</li> <li>It is recommended to provide for power supply to allow for future sensor operation of taps, toilet and lighting in sanitary facilities.</li> </ul> <p>For Fully Accessible and High Physical Support design categories:</p> <ul style="list-style-type: none"> <li>It is recommended that the hand wash basin is height adjustable between 700mm to 950mm from FFL.</li> </ul>

Clause No	Section Title	Best Practice Recommendations
-----------	---------------	-------------------------------

8

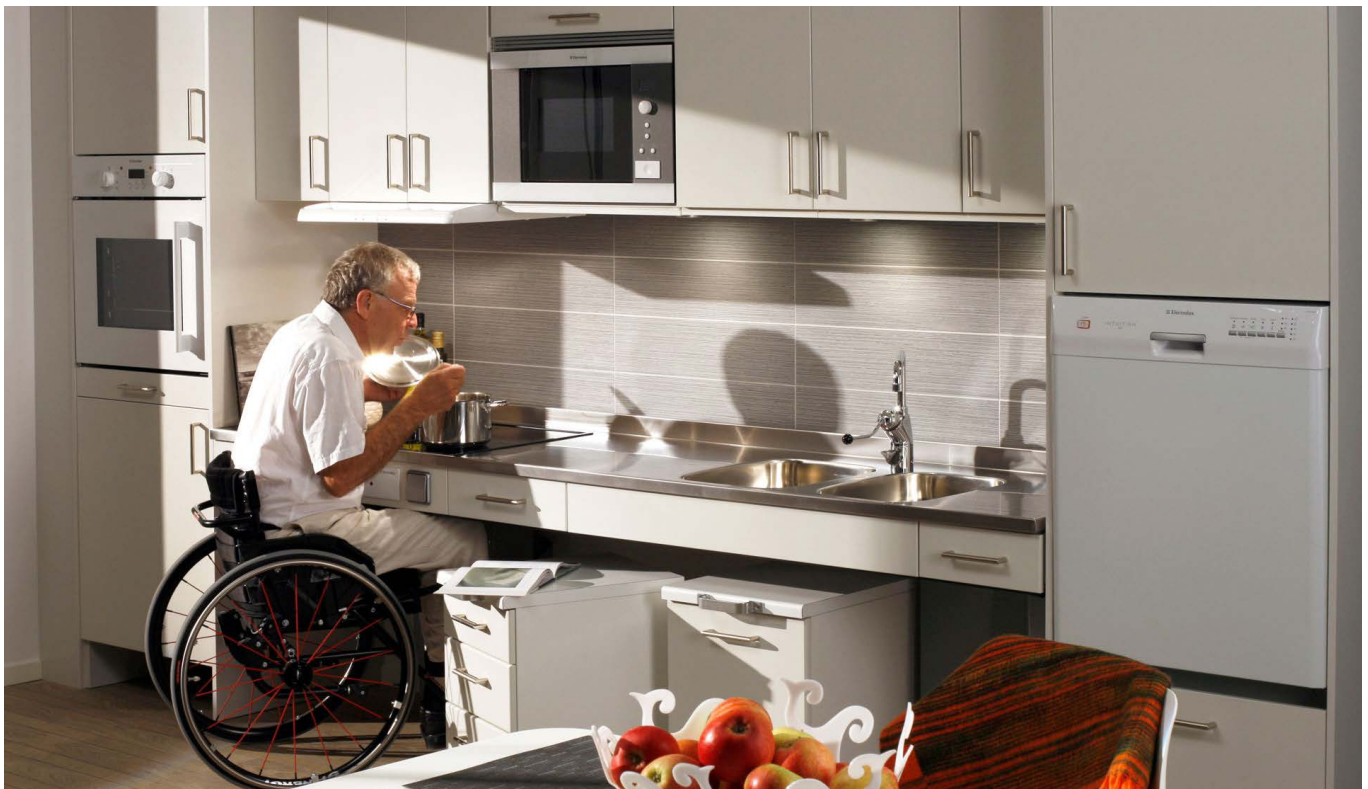
Kitchen

For all design categories:

- It is recommended to provide drawers for base cabinets.

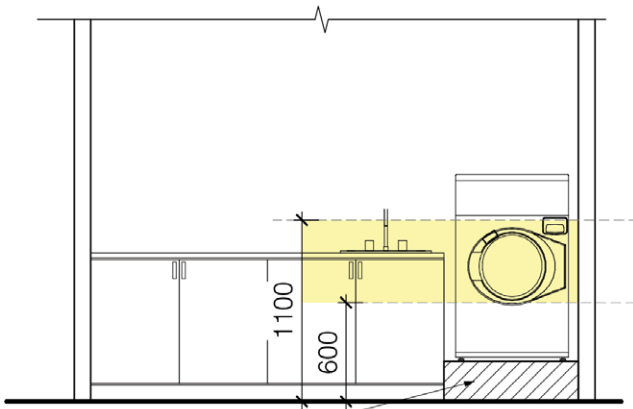
For Fully Accessible and High Physical Support design categories:

- It is recommended to provide cooktop on height adjustable benchtop with knee toe clearance as required by AS1428.1
- It is recommended to provide a shallow sink (maximum depth of 150mm) on height adjustable benchtop with knee toe clearance as required by AS1428.1. Note that in this case, the underside of the sink should be provided with a heat shield.
- It is recommended to provide microwave in an accessible location
- It is recommended to provide a shelf style drawer directly under the wall oven.
- It is recommended to provide the cooktop and oven isolation switch and a switch that operates the exhaust fan in an accessible location.
- It is recommended to provide automation of height-adjustable benchtop along with a safety mechanism and large buttons in front of benchtop edge to enable automation.
- It is recommended to provide a maximum depth of the height adjustable benchtop surface limited to 700mm to allow for maximum flexibility.
- In some cases the height adjustability of the benchtop will be required to be lower than 720mm and if so should be adjusted based on participant's requirements.



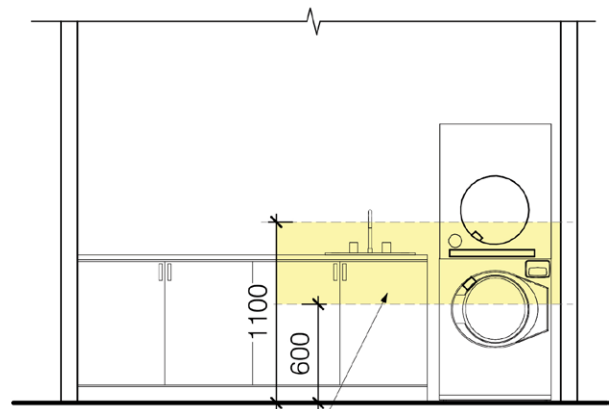
Clause No	Section Title	Best Practice Recommendations
-----------	---------------	-------------------------------

- |   |         |  |
|---|---------|--|
| 9 | Laundry | <p>For Fully Accessible and High Physical Support design categories:</p> <ul style="list-style-type: none"> <li>It is recommended to provide the operable parts of the front-loading washing machine (and separate dryer if provided) within a range of 600mm to 1100mm above FFL. This can be achieved by means of raising the washing machine from the FFL by means of a plinth or hob if required.</li> <li>It is recommended to provide a shallow tub (maximum depth of 150mm) on height adjustable benchtop with knee toe clearance as required by AS1428.1. Note that in this case, the underside of the laundry tub should be provided with a heat shield.</li> </ul> |
|---|---------|--|



Plinth can be used so that the operable parts of a front loading washing machine can be within the accessible height range of 600mm to 1100mm from FFL.

**Figure 20 (a) - Best practice recommendation for location of laundry appliances for accessibility**



It is preferred that the operable parts of a front-loading washing machine and dryer to be within the accessible height range of 600mm to 1100mm from FFL.

**Figure 20 (b) - Best practice recommendation for location of laundry appliances for accessibility**

- |    |         |   |
|----|---------|---|
| 10 | Bedroom | <p>For Fully Accessible and High Physical Support design categories:</p> <ul style="list-style-type: none"> <li>It is recommended to allow for height adjustable robes shelves and clothes hangers.</li> <li>It is recommended to locate windows such that they are not behind the bedhead and can provide views when the user is on the bed.</li> <li>Consider location for overnight wheelchair storage and charging points for power wheelchairs.</li> <li>Provide for door circulation spaces based on AS1428.1 based on any direction of approach.</li> <li>Provide 1540mm circulation spaces on all three sides of the Queen bed so that a person requiring use of a wheelchair can access all areas within the bedroom.</li> </ul> |
|----|---------|---|

Clause No	Section Title	Best Practice Recommendations
15	Use of Lifts	<p>It is recommended to provide automated passenger lift doors.</p> <p>Note: In some cases, such as residential buildings, NCC may require larger lift sizes.</p>
16	Common use external areas, private open space and landscaping	<ul style="list-style-type: none"> <li>• It is recommended to allow for a grassed assistance animal relief area.</li> <li>• It is recommended to provide common open space of at least 50% of available area or 15m<sup>2</sup> (whichever is the greater) with a min width of 2500mm as wheelchair accessible.</li> <li>• It is recommended to provide plants and materials that are neither toxic or poisonous to touch or ingest.</li> </ul>
20	Ceiling hoists	<p>It is recommended to provide bathrooms with power and inbuilt structure, capable of installation of a constant charge ceiling hoist. Minimum load capacity of the hoist to be 250kg. Hoist is to be capable of being either ceiling mounted or wall mounted.</p>
21	Heating and Cooling	<ul style="list-style-type: none"> <li>• It is recommended to provide air-conditioning to the Improved Liveability and Robust Design Category dwellings.</li> <li>• It is recommended to provide technology such as controls of air-conditioning to be operable via smart devices like iPads etc.</li> </ul>
22	Emergency power solutions	<p>It is recommended to provide emergency power solutions to Fully Accessible, Improved Liveability and Robust design categories as well.</p>
24	Assistive Technology	<p>It is recommended to provide video or intercom systems for the Fully Accessible design category.</p>
25	Fire safe design	<ul style="list-style-type: none"> <li>• It is recommended that a Fire Safety Engineer be consulted to determine the fire safety requirements of all SDA dwellings.</li> <li>• It is recommended to provide fire sprinklers for all design categories.</li> <li>• It is recommended to provide interconnected smoke alarms in bedrooms and living spaces for 1 participant dwellings.</li> <li>• It is recommended to provide smoke detectors that are wired to a fire panel for 2+ participant dwellings.</li> <li>• It is recommended to provide automatic sprinkler system for all 2+ participant dwellings. This may be offset by fire compartmentation in some buildings that are not sprinkler protected and may require fire engineering.</li> </ul>

# Legislation Commonwealth or State/territory Acts and referenced Australian Standards

Note: All referenced documents are to be the current applicable at the time of assessment.

Reference	Document
NCC Vol 1	National Construction Code, also referred to as Building Code of Australia - Vol 1 - Class 2 to 9 buildings.
NCC Vol 2	National Construction Code, also referred to as Building Code of Australia - Vol 2 - Class 1 and 10 buildings.
AS 1428.1	Design for access and mobility - Part 1: General requirements for access - New building work
AS/NZS 1428.4.1	Design for access and mobility – Part 4.1: Means to assist the orientation of people with vision impairment: Tactile ground surface indicators
AS/NZS 2890.6	Parking facilities, Part 6: Off-street parking for people with disabilities
AS 1735	Lifts, escalators and moving walks.

## Definitions and Glossary

Term	Definition
Accessible	Means having features to enable use by people with a disability, including persons using wheelchairs.
Accessway	Means a continuous accessible path of travel (as defined in AS 1428.1) to, into or within a building.
Assistive Technology	Any device or system that allows individuals to perform tasks they would otherwise be unable to do or increases the ease and safety with which tasks can be performed.
Australian Standards	Australian Standards are published documents setting out specifications and procedures designed to ensure products, services and systems are safe, reliable and consistently perform the way they are intended to. They establish a minimum set of requirements which define quality and safety criteria. Australian Standards can be purchased from an authorised distributor, a list of which is available at <a href="http://www.standards.org.au/search-for-a-standard">www.standards.org.au/search-for-a-standard</a>
BCA	The Building Code of Australia (BCA) is a uniform set of technical provisions for the design and construction of buildings and other structures throughout Australia which is part of the National Construction Code (NCC). It's produced and maintained by the Australian Building Codes Board (ABCB), whose primary aim is to achieve nationally consistent, minimum standards. It is legislated through state/ territory building regulations.
Circulation space	A clear, unobstructed area, to enable persons using mobility aids to manoeuvre.



Term	Definition
c/l	Centre line
Colour contrast	Colour contrast is the difference in colour that makes an object (or its representation in an image or display) distinguishable. In visual perception of the real world, contrast is determined by the difference in the colour and brightness of the object and other objects within the same field of view.
Continuous handrail	A handrail which is installed without a break or gap in the handrail between levels or floors.
External wall	Means an outer wall of a building which is not a common wall.
FFL	Means Finished Floor Level generally referenced to AHD or Australian Height Datum.
Fully Accessible	Housing that has been designed to incorporate a high level of physical access provision for people with significant physical impairment.
GPO	Means a 'general purpose outlet' or powerpoint.
High Physical Support	Housing that has been designed to incorporate a high level of physical access provision for people with significant physical impairment and requiring very high levels of support.
Improved Liveability	Housing that has been designed to improve 'liveability' by incorporating a reasonable level of physical access and enhanced provision for people with sensory, intellectual or cognitive impairment
Landing	A resting place on a path of travel or ramp or outside a door.
Lift	A passenger lift which complies with AS1735, with a lift car size of 1100mm (width) x1400mm (in the direction of travel) and does not include a stairway platform lift.
Luminance contrast	Means the light reflected from one surface or component, compared to the light reflected from another surface or component. Expressed as a percentage.
M	Means 'metres'
mm	Means 'millimetres'
NCC	The 'National Construction Code' (NCC) is an initiative of the Council of Australian Governments (COAG) developed to incorporate all on-site construction requirements into a single code. The NCC is comprised of the Building Code of Australia (BCA), Volume One and Two; and the Plumbing Code of Australia (PCA), Volume Three. and administered by the ABCB. References to BCA in the SDA Design Standard means NCC Vol 1 and/or Vol 2.
NDIA	National Disability Insurance Agency
NDIS	National Disability Insurance Scheme as administered by the National Disability Insurance Agency.
Participant	An individual who is eligible for the NDIS.
Ramp	An inclined surface on a continuous accessible path of travel between two landings with a gradient steeper than 1 in 20 but not steeper than 1 in 14.

<b>Term</b>	<b>Definition</b>
Ramp, kerb	An inclined surface on a continuous accessible path of travel with a maximum rise of 190 mm, a length not greater than 1520 mm and a gradient not steeper than 1 in 8, located within or attached to a kerb.
Ramp, step	An inclined surface on a continuous accessible path of travel with a maximum rise of 190 mm, length not greater than 1900 mm and a gradient not steeper than 1 in 10.
Ramp, threshold	An inclined surface on a continuous accessible path of travel with a maximum rise of 35 mm, length not greater than 280 mm and a gradient not steeper than 1 in 8.
Reasonable and necessary	A concept defined under Section 34 of the National Disability Insurance Scheme Act 2013, used by the NDIA to determine whether or not support is most appropriately funded by the NDIS, what kind of support is required and how much support is appropriate.
Required	Indicates that a statement is mandatory.
Restrictive practice	Any practice or intervention that has the effect of restricting the rights or freedom of movement of a person with disability, with the primary purpose of protecting the person or others from harm.
Robust	Housing that has been designed to incorporate a reasonable level of physical access provision and be very resilient, reducing the likelihood of reactive maintenance and reducing the risk to the participant and the community.
SDA	Means 'specialist disability accommodation' as funded under the NDIS by NDIA.
Shall	Indicates that a statement is mandatory.
Should	Indicates that a statement is a recommendation.
Site	Means the part of the allotment of land on which a building stands or is to be erected on.
Slip resistance	A property of a surface having a frictional force-opposing movement of an object across a surface.
Stair	A combination of more than two risers in a flight.
Step	A single change of level with one riser.
TGSIs	Tactile ground surface indicator (TGSIs) are truncated cones and/or bars installed on the ground or floor surface, designed to provide pedestrians who are blind or vision-impaired with a warning or directional orientation information.
Walkway	Any surface on a continuous accessible path of travel with a gradient not steeper than 1 in 20.
Wet area	Means an area within a building supplied with water from a water supply system, which includes bathrooms, showers, laundries and sanitary compartments and excludes kitchens, bar areas, kitchenettes or domestic food and beverage preparation areas.
WC pan	A toilet pan is also referred to as an WC pan with WC meaning 'Water Closet'

## Copyright Notice

© National Disability Insurance Agency July 2019

With the exception of any material protected by a trade mark, photos, figures, and when otherwise noted, this work is licensed under a Creative Commons Attribution 4.0 International licence CC BY 4.0 (<https://creativecommons.org/licenses/by/4.0/>).

The details of the relevant licence conditions are available on the Creative Commons website (accessible using the link provided) as is the full legal code for the CC BY 4.0 International licence.

Content from this work should be attributed to the National Disability Insurance Agency.



# ndis

For more information about the NDIS please contact:

[www.ndis.gov.au](http://www.ndis.gov.au)

National Disability Insurance Agency

 Telephone 1800 800 110

 Find us on Facebook/NDISAus

 Follow us on Twitter @NDIS

For people who need help with English

 TIS: 131 450

For people who are deaf or hard of hearing

 TTY: 1800 555 677

 Speak and Listen: 1800 555 727